



G2+
TECHNOLOGY

Galmar

SOUL KIT



USER MANUAL

G2+ 2-wire Installation Art 7W Monitor with Wi-Fi Connectivity

Code 50122126

TS5110 ART 7W EN REV.0120



CONTENTS

Contents	2
Recommendations.....	3
System operation	3
FA-G2+ power supply.....	4
Description	4
Installation	4
Soul panel.....	5-8
Description	5
Installation	6
Installation terminals	6
Configuration switches.....	7
Setting the audio level	7
Programming the proximity reader	8
Art 7W/G2+ monitor	9-23
Description	9
Installation	10
Installation terminals	10
Configuration switches.....	10
Main menu	11
Settings menu.....	12-15
Door panel call screen.....	16
Communication screen	17
Image and communication settings	18
Intercom menu.....	19-20
Recordings menu	21-23
G2Call app.....	24-31
Initial registering of a monitor to a Wi-Fi network	24-25
Registering of a monitor connected to the network.....	26
Advanced settings of a registered monitor	27-28
Main screen	29
Communication screen	30-31
Wiring diagrams.....	32-38
Cross sections and distances.....	32
One apartment with one access panel and one monitor	32
One apartment with two access panels and one monitor	32
One apartment with up to two access panels and up to four monitors in daisy chain connected.....	33
One apartment with up to two access panels and up to four monitors in distribution	33
Two apartments with up to two access panels and up to four monitors in daisy chain connected	34
Four apartments with up to two access panels and up to four monitors in daisy chain connected	35
Four apartments with up to four access panels and up to four monitors in daisy chain connected.....	36
Connection of a lock release.....	37
Connection of an auxiliary device at the relay output	37
Connection of an output button.....	38
Connection of an external camera	38
Connection for an apartment door button.....	38
Special codes	39-41
Cleaning the monitor	42
Cleaning the door panel.....	42
Notes	43
Compliance.....	44



RECOMMENDATIONS

- Preferably use a Golmar **RAP-GTWIN/HF** cable (2x1mm²).
- The wiring must run at least **40cm away from any other wiring**.
- **Always disconnect the power supply** before making modifications to the device.
- The installation and handling of these devices must be carried out by **authorised personnel**.
- Check all connections before starting the device.
- Always follow the instructions contained in this manual.





SYSTEM OPERATION



To make a call, the visitor must press the button of the apartment; an audible sound indicates that the call is being made and LED  will illuminate. At this moment, the apartment's monitor(s) receive(s) the call. If the visitor presses the button for another apartment by mistake, the call can be cancelled by pressing the button for the correct apartment.

In systems with several access doors, the other door panel(s) will be automatically disconnected. If another visitor tries to call, a number of telephone tones will be heard to indicate that the system is busy and LED  will illuminate.

Upon receiving the call, the image will appear on the screen of the master monitor (and slave 1, if it exists) without the visitor knowing and icon  displayed on the screen will blink green. To view the image from slave monitors 2 or 3, press the screen for the image to appear. If the call is not answered within 45 seconds, LED  will turn off and the system will become free.

If call transfer to your mobile phone has been programmed, you can cancel the transfer at any time from the monitor, with it being necessary to communicate with the door panel from the main menu.

To establish communication, press off-the-hook icon  on the screen. Door panel LED  will illuminate. Connection will last for 90 seconds or until on-the-hook icon  is pressed. When communication ends, LED  will turn off and the system will become free.

To open door  or activate auxiliary output  of the door panel, press the corresponding icon. A single press activates the lock release or auxiliary output for 3 seconds, and LED  on the door panel illuminates. The activation time is programmable, as indicated on pp. 40-41.

Detailed operation of the monitor is described on pp. 11-23.

The owner of the apartment can activate the lock release by holding the proximity key over the reader. If the proximity key is held for three seconds, the auxiliary relay output will be activated.

FA-G2+ POWER SUPPLY

Description

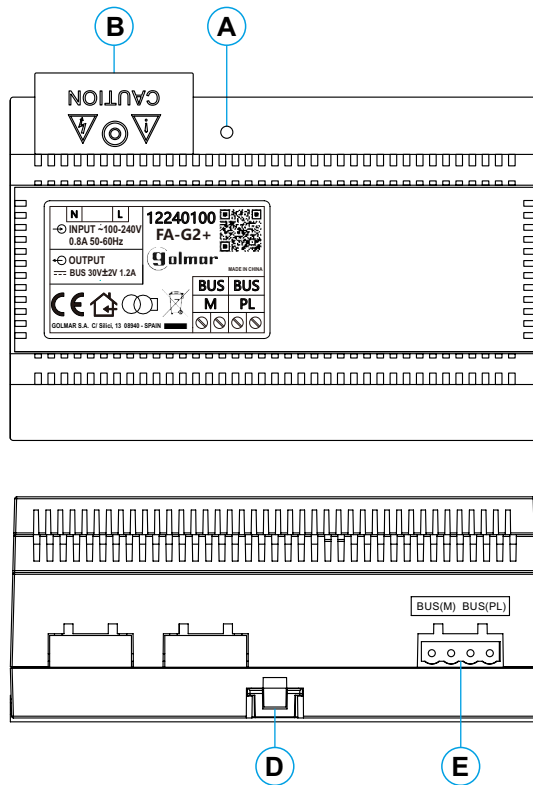

- A. On/off indicator light.
- B. Protective cover for the current input.
- C. Detail of current input terminals without protective cover.
- D. Fastening tab on DIN rail.
- E. Installation terminals.

Installation

The fitting and handling of the power supply must be carried out by authorised personnel in the absence of electrical current.

Install the power supply in a dry, protected and ventilated location. Make sure that the vents are not obstructed. Use a DIN 46277 rail for fastening (8 elements).

Note that current regulations stipulate that the power supply must be protected by a circuit breaker.

To prevent electric shock, do not remove the protective cover without first disconnecting the power supply. Replace it once all connections have been made.

Connect the wires to the installation terminals following the instructions in the diagrams.

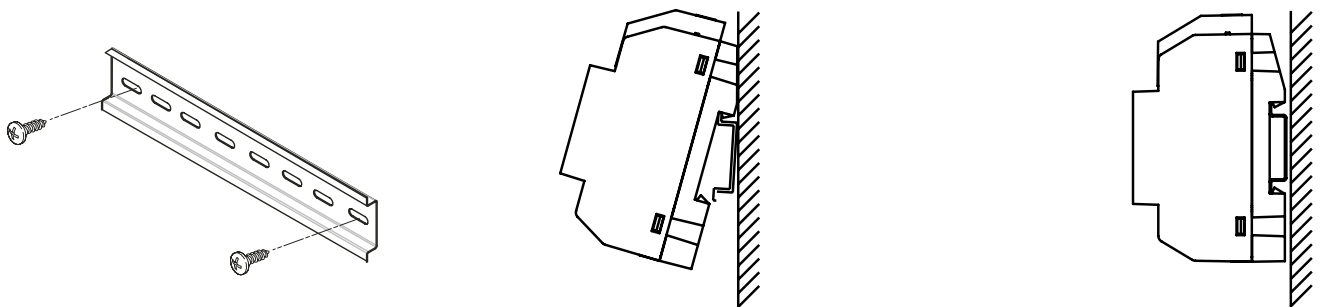

SOUL PANEL

Description

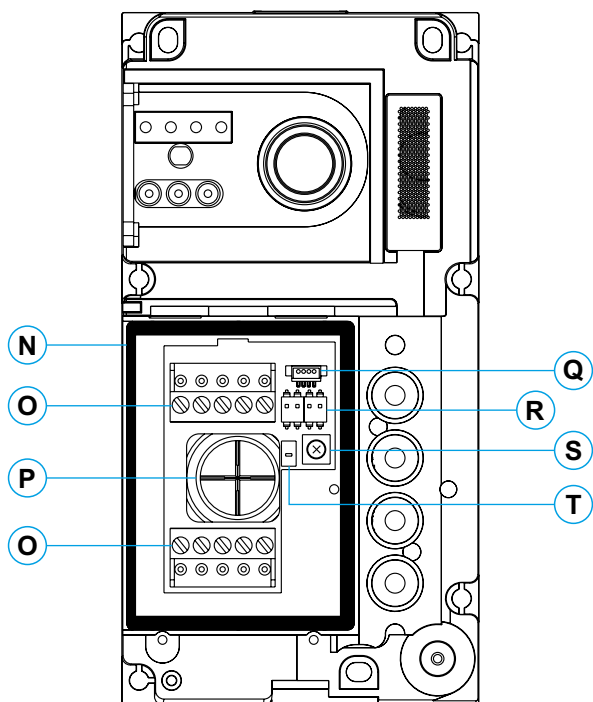
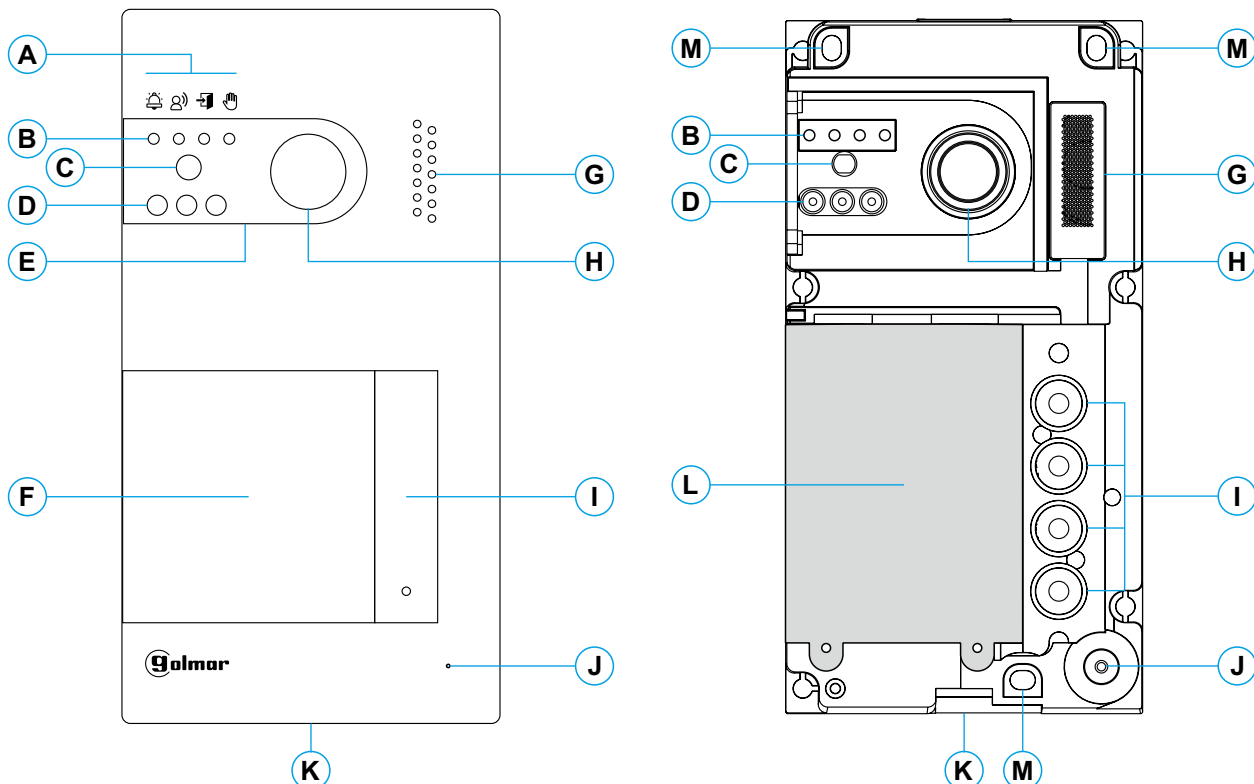

- A.** System status icons:
 ☎ Call in progress.
 📞 Communication established.
 🔓 Lock release activated.
 🖱 System busy.
- B.** System status indicator lights.
- C.** Ambient lighting sensor.
- D.** Night viewing lighting.
- E.** Protective polycarbonate.
- F.** Proximity card reader.
- G.** Speaker grill.
- H.** Colour camera.
- I.** Call button(s).
- J.** Microphone hole.
- K.** Front fixing screw.
- L.** Proximity reader.
- M.** Wall fixing hole (x3). **Do not overtighten the fixing screws.**
- N.** Proximity reader gasket.
- O.** Installation terminals.
- P.** Cable grommet.
- Q.** Proximity reader connector.
- R.** Configuration switches.
- S.** Volume control potentiometer.
- T.** Proximity reader configuration button.

SOUL PANEL

Installation

The door panel has been designed to withstand diverse environmental conditions. It is however advisable to take extra precautions to prolong its service life, such as locating it in a covered area.

For optimum image quality, avoid direct contact from light sources (sunshine, street lights, etc.).

For correct installation: (locate the top of the door panel at a height of 1.65m).

1. Remove the metal front piece of the door panel by loosening the bottom screw with the Allen key supplied. On the back of the front piece, you will find the button personalisation label.
2. Remove the screws that secure the proximity reader.
3. Present the door panel to the wall, positioning the top at 1.65m. Pass the installation cables through the cable grommet.
4. Drill three 6mm holes at the indicated points (M), see p. 5. Insert the plugs supplied and fix the door panel to the wall using the screws supplied.
5. Connect the cables to the removable terminals following the instructions in the installation diagrams.

Before replacing the proximity reader and closing the door panel, make the necessary settings (proximity key programming, audio level setting, etc.), as indicated throughout this manual. Make sure that the proximity reader gasket is properly fitted.

Installation terminals (O)

For ease of installation, the installation terminals are removable and supplied in a separate bag. Once the terminals are wired, place them in position.

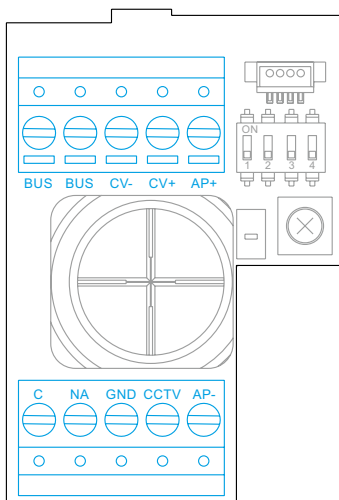

BUS, BUS: communications bus (non-polarised).

CV-, CV+: lock release output 12Vdc (maximum 150mA).

AP+, AP-: remote activation button connection.

Note: For correct operation, the monitor's address 1 must be connected to the Bus.

C, NA: potential-free relay output (maximum 6A/24V).

GND, CCTV: input for external analogue camera.

SOUL PANEL

Configuration switches (R)

Configuration changes should be made with the equipment turned off. If they are performed with the equipment turned on, disconnect it for 10 seconds after any modification.

All switches are factory set to OFF.

Note: Configuration of the DIP switches for the SOUL/1, SOUL/2 and SOUL/4 door panels with version V04 and later.

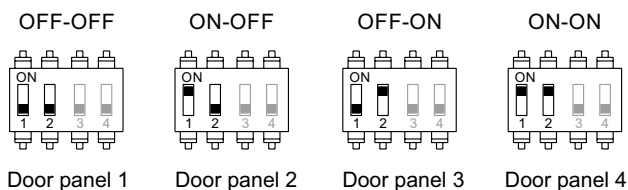

Switches 1 and 2.
Defines the door panel address.

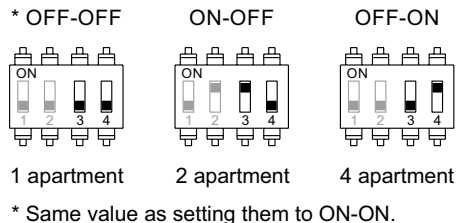

Switches 3 and 4.
Define the number of apartments:
1: all buttons call apartment 1.
2: the two bottom buttons call apartment 1, the two top buttons call apartment 2.
4: each button calls one apartment.

Setting the audio level

If the audio volume on the door panel after starting up the device is not adequate, use the volume control potentiometer (S). This setting affects the communication and confirmation tone audio level.

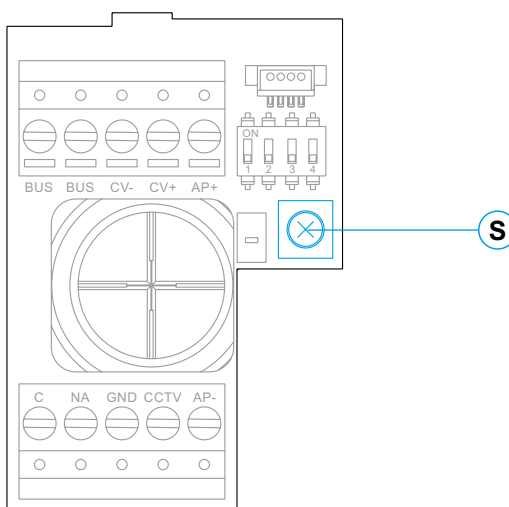

SOUL PANEL

Programming the proximity reader (L)

Make sure that the device is powered and the reader is connected to the door panel (Q).

To add user keys (up to 60) to the memory of the proximity reader, it is necessary to create a programming key and a user registration key. In order to facilitate identification, we recommend using the yellow key to programme and the blue key to register users. Use the grey ones as user keys.

Creating programming and registration keys.

NOTE: This process completely deletes the memory of the proximity reader.

Press the programming button of the proximity reader (T): the door panel will emit six short tones. Within ten seconds, hold the programming key up until the door panel emits a short confirmation tone and then hold the user registration key up until the door panel emits a long confirmation tone. If no key is held up within ten seconds of pressing the programming button, the door panel will emit a long tone and the memory will have been completely deleted.

Once the programming and registration keys have been created, the addition and deletion of user keys can be done with the door panel closed.

Adding user keys.

Hold the registration key up to the reader: the door panel will emit four short tones. One by one, hold up the user keys that you wish to add until a short tone is emitted for each key added. Ten seconds after adding the last key, the door panel will emit a long tone to confirm completion of the process.

Deleting all user keys.

Hold the programming key up to the reader: the door panel will emit four short tones. Hold up the registration key, and the door panel will emit a long tone to confirm deletion of all of the keys. After ten seconds, if the registration key has not been held up, the door panel will emit a long tone to confirm completion of the process.

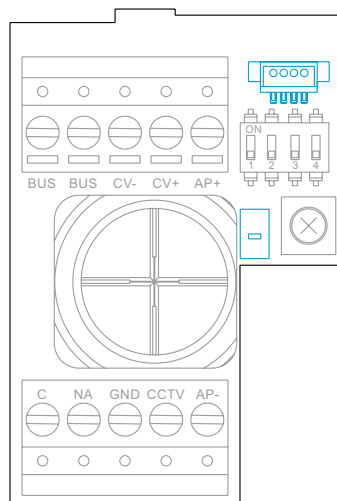

ART 7W/G2+ MONITOR

Description

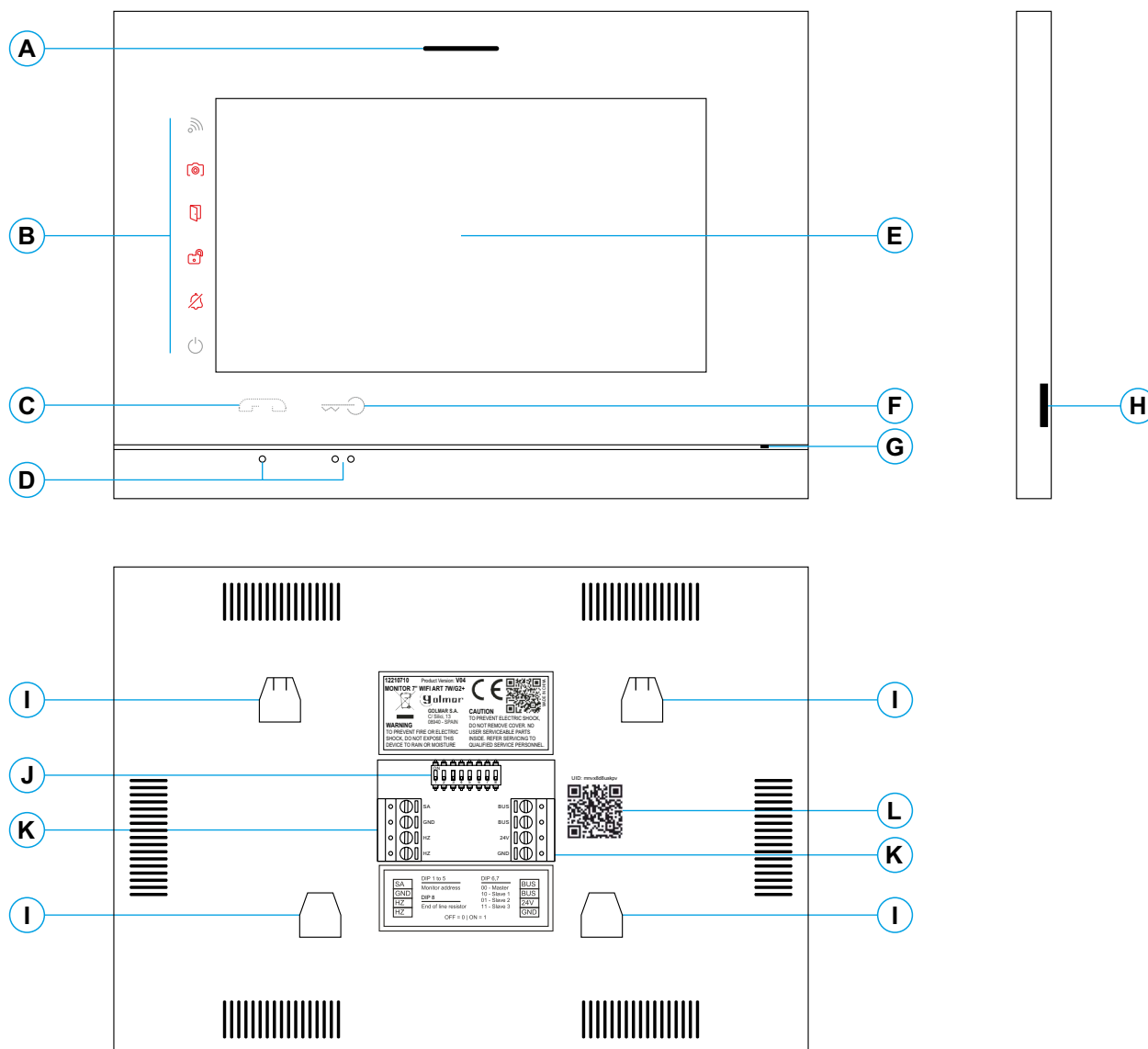

A. Speaker.

B. Notification icons:

- Power on indicator.
- Do not disturb.
- Auxiliary relay activated.
- Door opening.
- New image/video.
- Wi-Fi transfer activated.

C. Hidden start/stop communication button:

Note: ART 7W/G2+ monitor 'V.01 + No. 6539 and V.02' or later: For the visually impaired, by default deactivated (see p. 40 'special codes').

D. Raised dots for the visually impaired.

E. Touch screen.

F. Hidden door opening button.

Note: ART 7W/G2+ monitor 'V.01 + No. 6539 and V.02' or later: For the visually impaired, by default disabled (see p. 40 'special codes').

G. Microphone.

H. MicroSD card slot (not included).

Type: MicroSD Class 10 from 4Gb to 128Gb.

I. Wall mounting connector fixing (x4).

J. Configuration switches.

K. Installation terminals.

L. UID code label of the monitor.

ART 7W/G2+ MONITOR

Installation

Avoid dusty or smoky environments or locations near sources of heat.

For proper installation, use the template supplied with the product.

1. Position the top of the template at a height of 1.65m.
2. If you are going to use an embedding box to pass the wiring through, make sure that it is in line with the holes corresponding to the box model chosen and fix the connector. If you prefer to fix the connector directly to the wall, make four 6mm holes at the points indicated (A), insert the wall plugs supplied and screw in the connector.
3. Pass the installation wires through the middle hole and connect them to the removable terminals as shown in the wiring diagrams. Before connecting the removable terminals to the monitor, configure the switch as indicated below.
4. Connect the removable terminals to the monitor and place the monitor in front of the connector, making sure the fixings line up. Move the monitor downwards to secure it.

Installation terminals (K)

For ease of installation, the installation terminals are removable and supplied in a separate bag. Once the terminals are wired, place them in position.

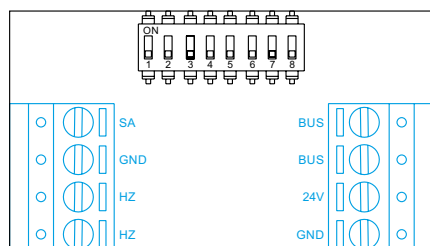

BUS, BUS: communications bus (non-polarised).

24V, GND: local power input.

SA, GND: auxiliary call repeater output (maximum 50mA/12V).

HZ, HZ: apartment front door button input:

Note: ART 7W/G2+ monitor 'V.01 + No. 6539 and V.02' or later: Connect only on the master monitor. The signal received is then transmitted to the slave monitors in the same apartment through the BUS.

Configuration switches (R)

Switches 1 to 5.

These assign the address of the corresponding monitor to its call button on the door panel. Switches 4-5 must remain in the OFF position.

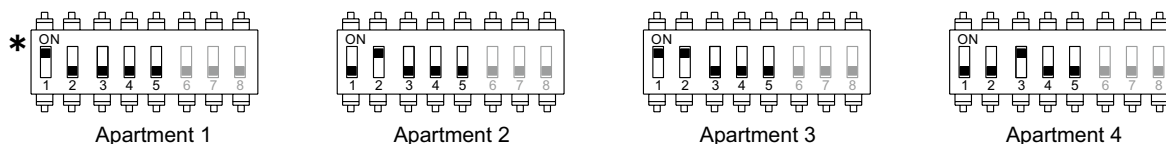

* Apartment 1 (DIP 1 to ON) ART 7W G2+ monitor with V.04 and later.

Switches 6 and 7.

These define whether the monitor is master or slave. Each apartment must have one master monitor, and only one. In the case of apartments with more than one monitor, the monitor with Wi-Fi transmitter should always be the master.

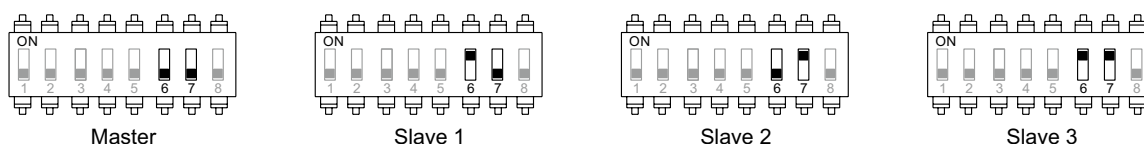

Switch 8.

This activates the end-of-line resistance in the ON position. Activate it in monitors where the bus cable ends. Deactivate it only in intermediate monitors.

ART 7W/G2+ MONITOR

Main menu

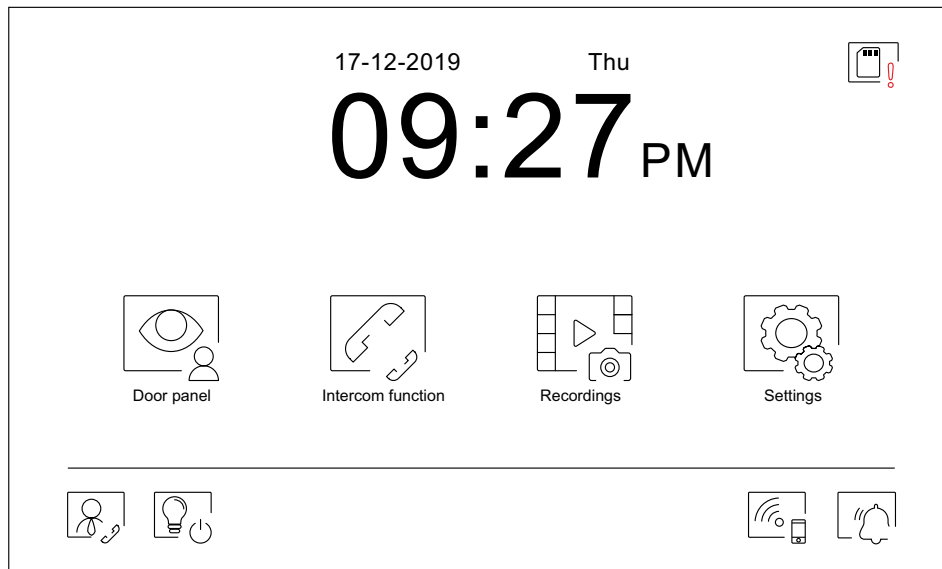

If the device is in standby (screen off), touch any part of the screen to activate it and bring up the main menu. The device will return to standby mode after 20 seconds without activity.



Display the image from the door panels and cameras connected to the system.

Note: ART 7W/G2+ monitor 'V.01 + No. 6539 and V.02' or later: This enables the door panel camera to be changed, the audio of the corresponding door panel to be activated and the door to be opened.



Access the menu for intercom with other monitors in the system.



Display the list of images recorded in the device memory. If there are new or unseen images, the number will be displayed in the top right of the icon and notification icon  will illuminate. If the number is greater than 9, three points will be displayed.

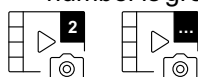

Change the system settings.



No function. The button can be set to be displayed or not in the main menu, see 'Screen' settings  on p. 13.



No function. The button can be set to be displayed or not in the main menu, see 'Screen' settings  on p. 13.



Indicates that the inserted MicroSD card must be formatted from the monitor. Press to access the storage functions menu and format the card.



Press to activate or deactivate Wi-Fi transmission. The icon will change colour (white on, grey off) and notification icon  will illuminate depending on the status.

Note: ART 7W/G2+ monitor 'V.01 + No. 6539 and V.02' or later:

Press for 3 seconds to activate/deactivate Wi-Fi transmission.

Important: Only the master monitor can activate Wi-Fi transmission.



Press for 3 seconds to activate or 1 second to deactivate the 'Do not disturb' function (the monitor does not sound when a call is received). The notification icon will illuminate depending on the status.

Important: New main menu with ART 7W G2+ monitor with V.04 and later.

ART 7W/G2+ MONITOR

Settings menu

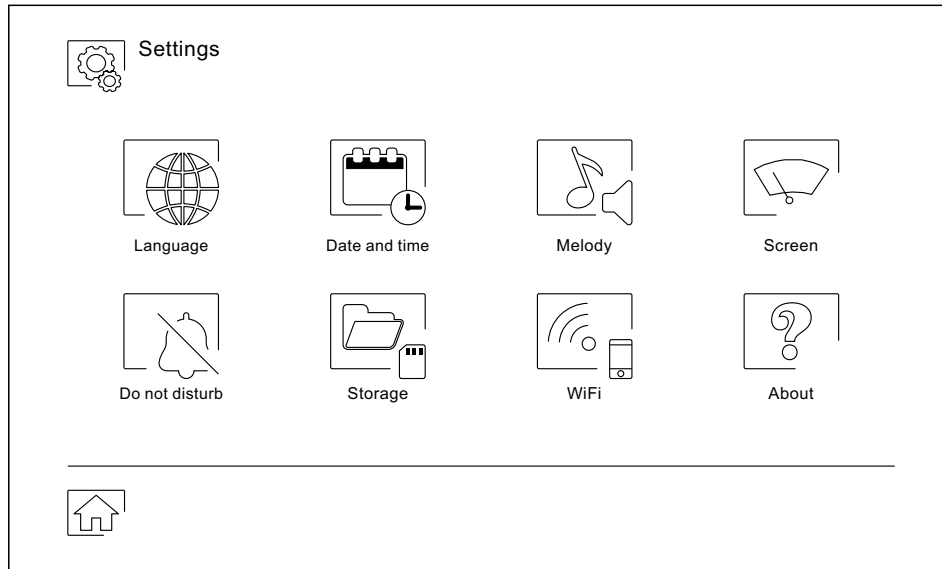

Use icon  to return to the main menu.



Select one of the 16 languages available for the user interface. Once selected, confirm by pressing icon , and the monitor returns to the settings menu.

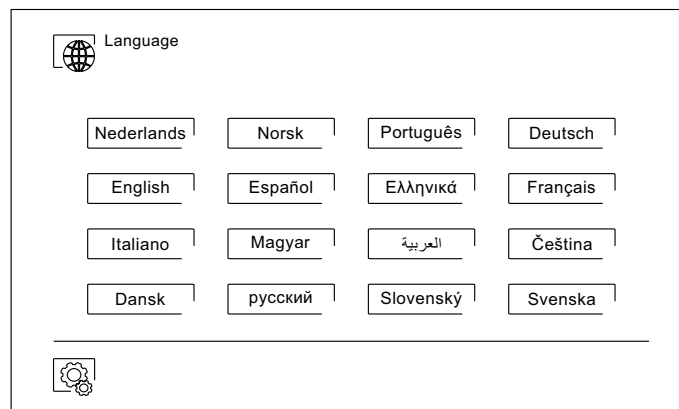

Important: New settings menu with ART 7W G2+ monitor with V.04 and later.

ART 7W/G2+ MONITOR

Settings menu



Set the date and time of the system, and the presentation format. Change the values by sliding up or down, and use the arrows to change the formats. Validate the changes made with icon , and the monitor will return to the settings menu.

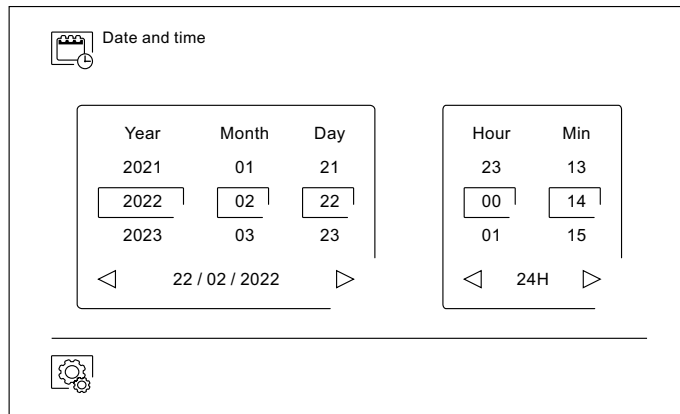

Adjust the call volume and identify the origin of the calls when you are not in front of the monitor, select the desired volume and melodies using the arrows. Once finished, confirm your selection with icon .

1st ringtone screen

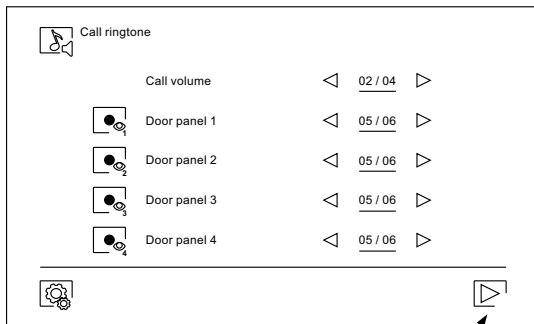

Access the 2nd screen

2nd ringtone screen

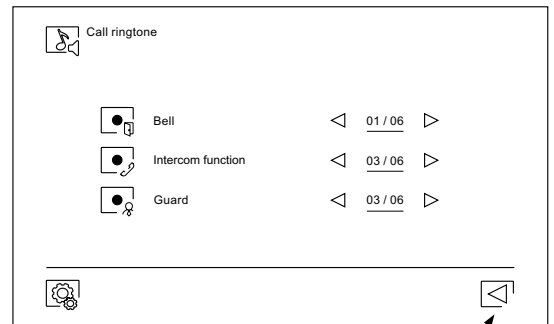

Access the 1st screen



Customise the monitor with one of the six available wallpapers, display the guard buttons, light (no function) and the date/time on the main menu screen. Validate the changes made with icon , and the monitor will return to the settings menu.

The option selected is shown in the main menu.

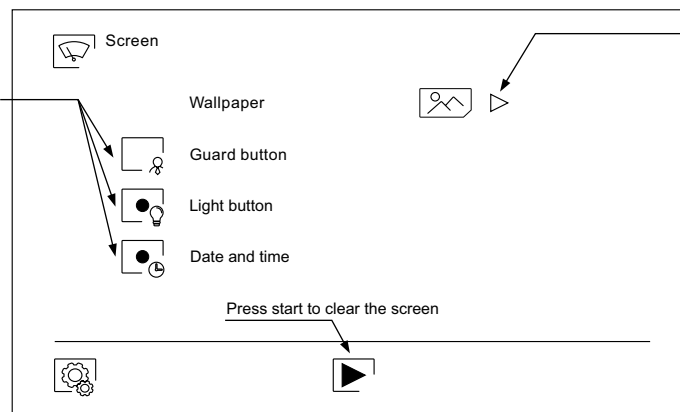

Access wallpapers:



Important: New settings menu with ART 7W G2+ monitor with V.04 and later.

ART 7W/G2+ MONITOR

Settings menu



In the 'Do not disturb' settings, you can set a period of time during which the monitor will not sound when receiving calls. To do so, select the do not disturb function and choose the time period. From the main menu, you can enable and disable the 'Do not disturb' function regardless of the timer status.

If you wish to be contacted from another monitor in another apartment, activate the intercom function.

To activate the automatic door opening function (3 seconds after receiving a call from the door panel), select the 'Automatic door opening' function. Then choose the time period. **(This function is disabled by default. To enable it, see pp. 39-40).**

Validate the changes made with icon , and the monitor will return to the settings menu.

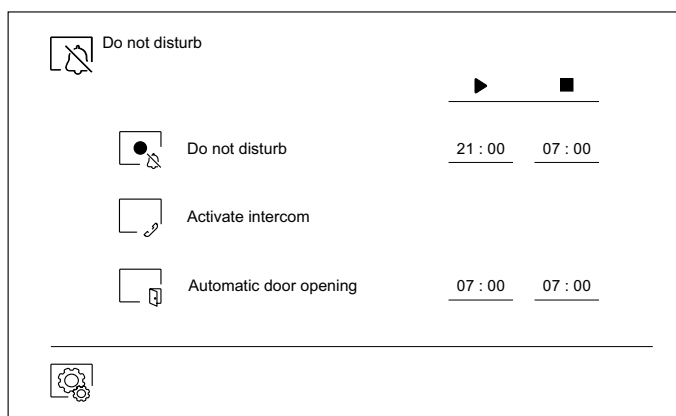

In some countries, the law does not permit the storage of images or videos for more than 30 days after recording. The automatic deletion function performs this task for you. You can disable this function if your country's legislation does not require it, or under your responsibility.

If you have not inserted a MicroSD card into your monitor, only still images can be recorded in the internal memory of the monitor (up to 100). If you have inserted one, the images and videos will always be recorded on the card, and the images in the internal memory cannot be displayed until you copy them to the card.

From this menu, you can delete contents, copy from the internal memory to the SD card and format the card. Any of these actions will require confirmation.

Use icon  to return to the settings menu.

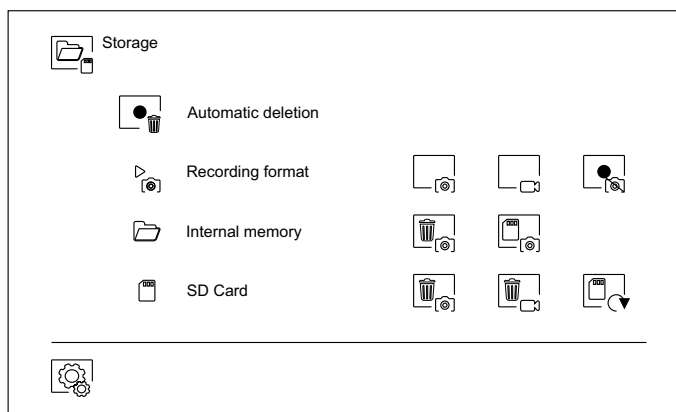

Important: New settings menu with ART 7W G2+ monitor with V.04 and later.

ART 7W/G2+ MONITOR

Settings menu



During the first startup of the device, we recommend resetting the Wi-Fi parameters using icon .

Note that **only the master monitor can activate Wi-Fi transmission.**

The Wi-Fi menu shows information about the identity of the monitor (UID), the name of the network to which it is connected (SSID) and the signal strength. To connect the monitor to your Wi-Fi network, you must use the G2Call app, as detailed below.

Using icon , select the desired transfer mode ('instant' start of the call transfer to the mobile phone within 3 seconds of making the call on the door panel, 'No answer' start of the call transfer to the mobile phone 50 seconds after making the call on the door panel, 'Do not divert' there is no call transfer to the mobile phone. Validate the changes made with icon , and the monitor will return to the settings menu.

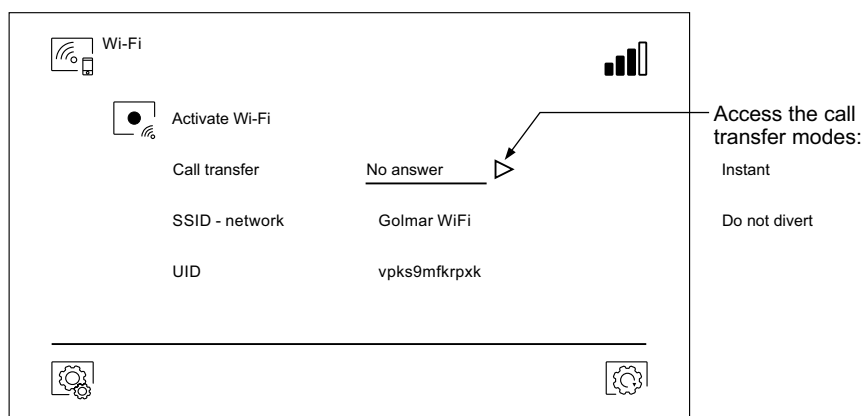

The 'About' screen provides information about the device, such as the monitor version and its address.

Press 'Instructions manual' or 'Apps' to display the QR code that will take you to the updated downloads of this instruction manual and the G2Call app for your mobile phone.

Use icon to restore factory settings, such as language, melodies, etc. Wi-Fi parameters will not be modified.

Use icon to return to the settings menu.

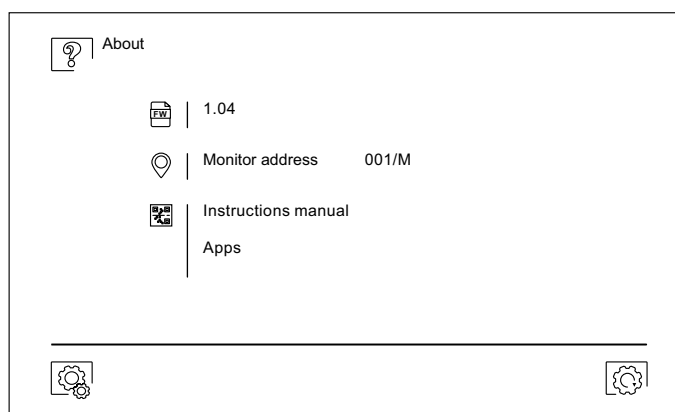



Important: New settings menu with ART 7W G2+ monitor with V.04 and later.

ART 7W/G2+ MONITOR

Door panel call screen



This screen is displayed when receiving a call or pressing icon  of the main menu. During a call, icon  displayed on the screen will blink green (during the call process). In the top centre of the screen, the date and time are shown and, on the right, the source of the image is displayed (door panel 1, door panel 2, camera 1 or camera 2). The call has a duration of 45 seconds.



The ringtone ends.





Access the image and communication settings menu.



Change the source of the image as long as the system has more than one door panel or has an external camera connected and display has been activated (see p. 40). It is possible to make the change during display, call and communication processes.



Start  or end  audio communication with the door panel displayed. Communication has a maximum duration of 90 seconds. Once communication has ended, the screen will turn off.





Activate the lock release (or device connected to the CV output of the door panel) for 3 seconds (factory setting, programmable by the installer; see pp. 39-41). During activation, indicator  will illuminate.





Activate the lock release (or device connected to the relay output of the door panel) for 3 seconds (factory setting, programmable by the installer; see pp. 39-41). During activation, indicator  will illuminate.



A few seconds after receiving a call, it automatically takes a photograph. In the top left of the screen, icon  is displayed and indicator  will illuminate.

By pressing, it takes a photograph. (See p. 14 to set the recording mode).



if you have a MicroSD card inserted, it starts recording a 15-second video within a few seconds of receiving the call. Otherwise, it will take a photograph. In the top left of the screen, icon  is displayed and indicator  will illuminate.

By pressing, it records a video. (See p. 14 to set the recording mode).

Important: New settings menu with ART 7W G2+ monitor with V.04 and later.

ART 7W/G2+ MONITOR

Communication screen



This screen is displayed during a communication process. In the top centre of the screen, the date and time are shown and, on the right, the source of the image is displayed (door panel 1, door panel 2, camera 1 or camera 2).



End audio communication with the door panel displayed and then show the main menu.



Access the image and communication settings menu.



Change the source of the image as long as the system has more than one door panel or has an external camera connected and display has been activated (see p. 40). It is possible to make the change during display, call and communication processes.



Start or end audio communication with the door panel displayed. Communication has a maximum duration of 90 seconds. Once communication has ended, the screen will turn off.



Activate the lock release (or device connected to the CV output of the door panel) for 3 seconds (factory setting, programmable by the installer; see pp. 39-41). During activation, indicator will illuminate.



Activate the lock release (or device connected to the relay output of the door panel) for 3 seconds (factory setting, programmable by the installer; see pp. 39-41). During activation, indicator will illuminate.



A few seconds after receiving a call, it automatically takes a photograph. In the top left of the screen, icon is displayed and indicator will illuminate.

By pressing, it takes a photograph. (See p. 14 to set the recording mode).



If you have a MicroSD card inserted, it starts recording a 15-second video within a few seconds of receiving the call. Otherwise, it will take a photograph. In the top left of the screen, icon is displayed and indicator will illuminate.

By pressing, it records a video. (See p. 14 to set the recording mode).

Important: New settings menu with ART 7W G2+ monitor with V.04 and later.



ART 7W/G2+ MONITOR

Image and communication settings

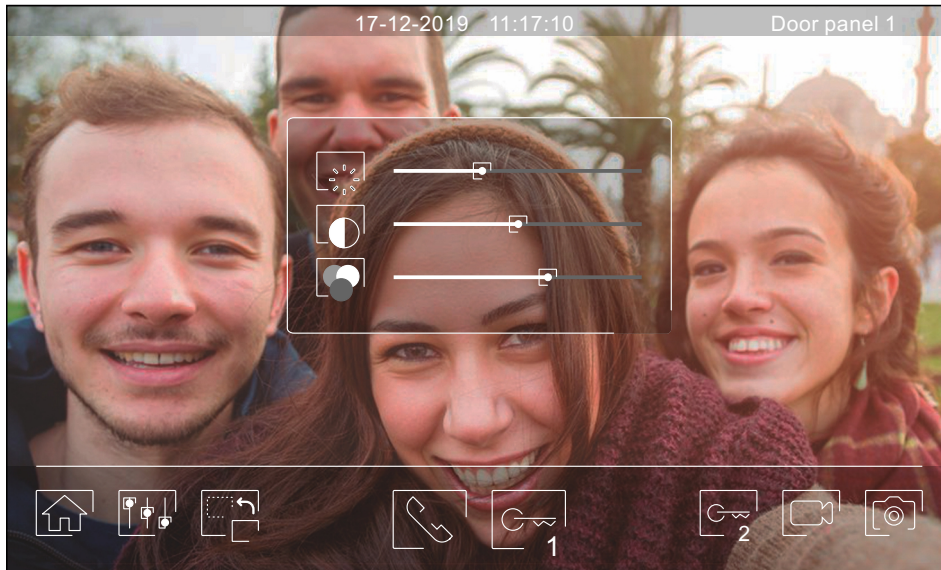
During the display or call process, it is possible to adjust the image parameters (brightness, contrast and colour). Press icon  and use the slider bars to adjust the settings. By pressing the icon again, the settings window will disappear.



During the communication process, it is possible to adjust the image parameters (brightness, contrast and colour), and the audio level of the monitor speaker.

Press icon  and use the slider bars to adjust the settings. By pressing icon  again, the settings window will disappear.

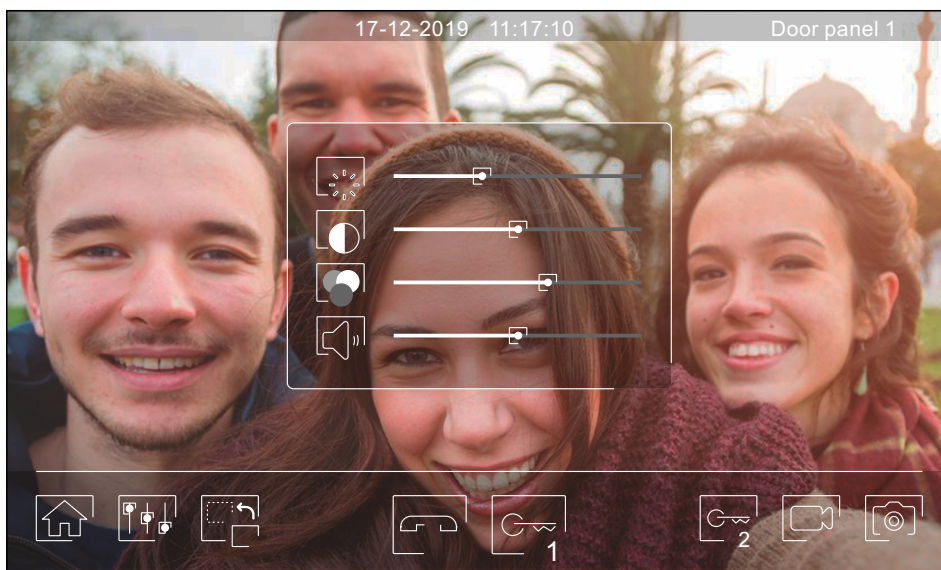

Important: New settings menu with ART 7W G2+ monitor with V.04 and later.

ART 7W/G2+ MONITOR

Intercom menu

From this menu, you can contact other monitors in your apartment (internal intercom) or building (external intercom). To do so, your monitor and the monitor called must have the intercom function activated from the 'Do not disturb' menu (see p. 14).

Use icons  and  to switch between internal and external intercom screens.



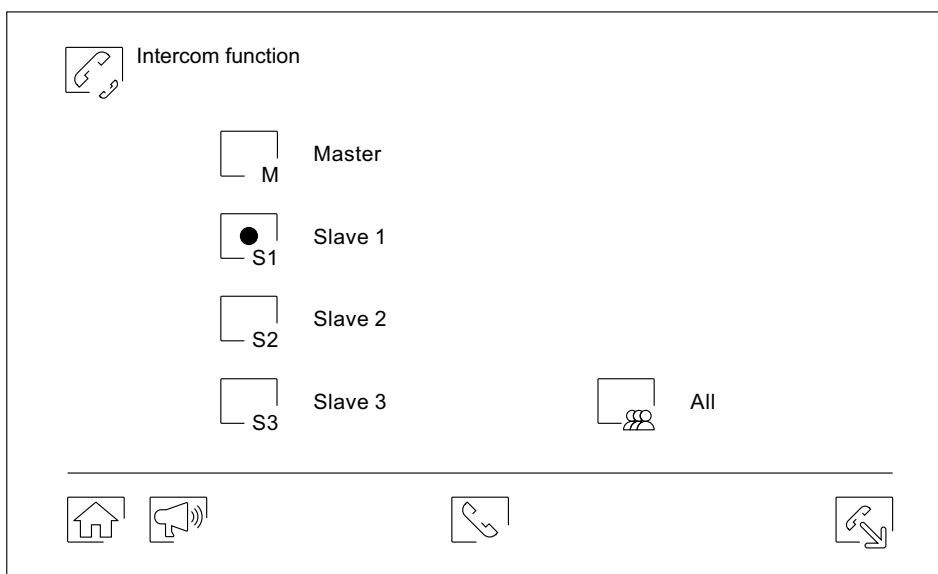

If during an intercom process with another monitor a call is received from the door panel, the intercom process will be terminated, and the door panel call will be received on the corresponding monitor.

Use icon  to return to the main menu.





Internal intercom.

Select the monitor you wish to communicate with. The monitor that appears selected by default is your own. You will find information about the address of the monitor in the 'About' menu (see p. 15). If you select the 'All' option, the rest of the monitors will receive the call, with communication established with the first one that answers.

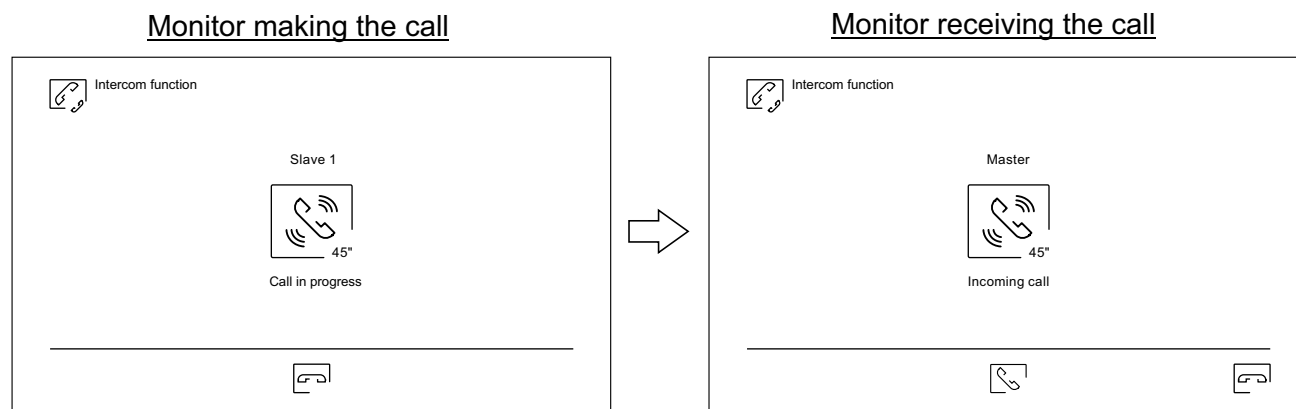
To make a call, press icon , and the 'Call in progress' message will appear on the screen. The monitor(s) that receives the call will display the 'Incoming call' message, followed by the monitor making the call. To cancel the call, press icon , and the 'Communication completed' message will appear. To establish communication, press icon ; communication will end after 90 seconds or when icon  is pressed.



To perform an internal broadcast process, select the monitor to call and then press icon ; it is now possible to talk, listen, and raise and lower the communication volume from each of these 2 monitors. Communication will last for 90 seconds or until icon  is pressed.

Important: New settings menu with ART 7W G2+ monitor with V.04 and later.



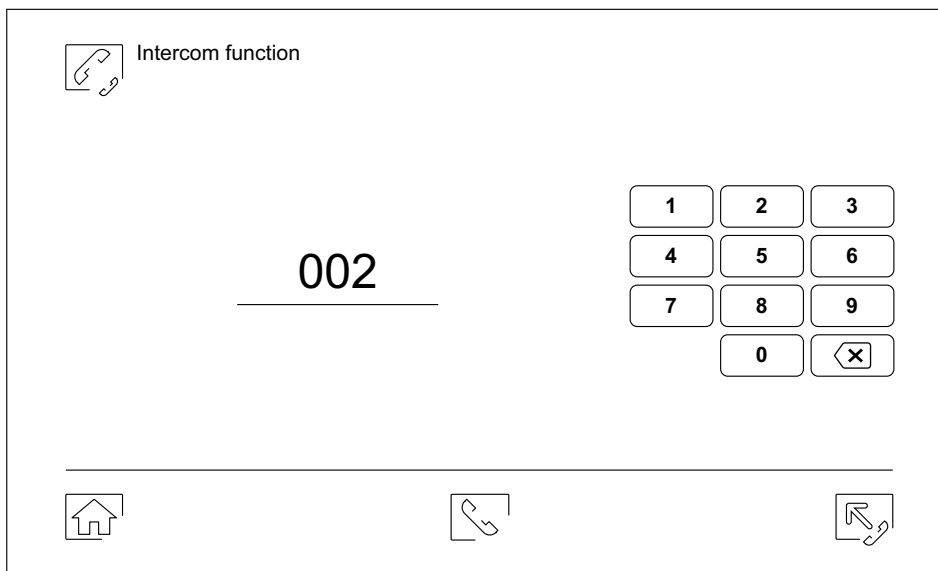

ART 7W/G2+ MONITOR

Intercom menu



External intercom.

Enter the code of the apartment with which you wish to communicate using the keypad.

To make a call, press icon , and the 'Call in progress' message will appear on the screen. The master monitor of the apartment called will display the 'Incoming call' message, followed by the monitor making the call. To cancel the call, press icon , and the 'Communication completed' message will appear. To establish communication, press icon ; communication will end after 90 seconds or when icon  is pressed.

Apartment monitor 001 makes the call

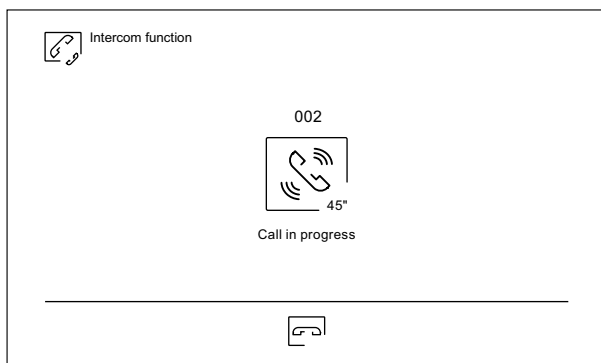

Apartment monitor 002 receives the call

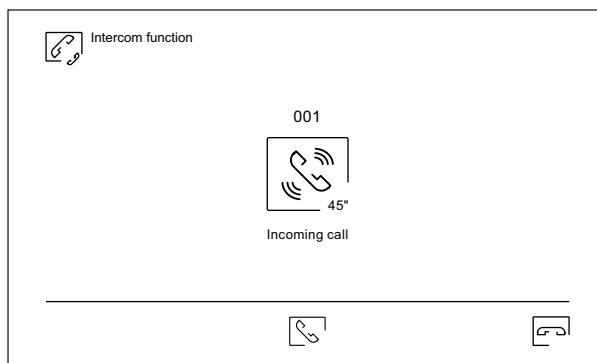

Apartment monitor 001 in communication

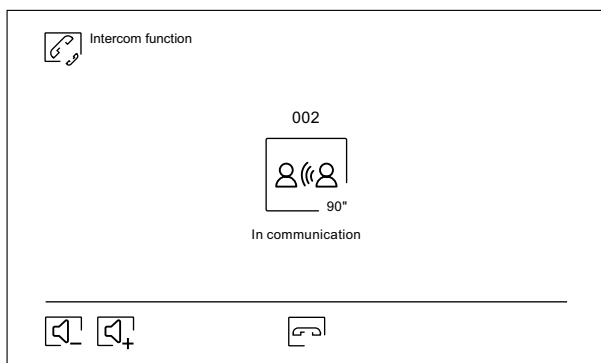

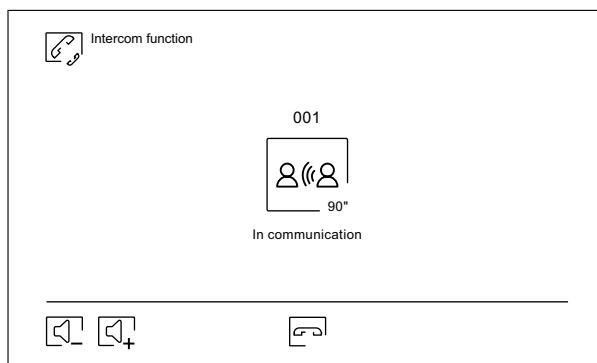

Apartment monitor 002 in communication





Important: New settings menu with ART 7W G2+ monitor with V.04 and later.

ART 7W/G2+ MONITOR



Recordings menu

This menu displays the list of images saved in the monitor or on the SD card if inserted. Press icon  to access the video recordings saved on the SD card and icon  to return to the images list. There are 10 recordings per page and the number of pages is shown at the bottom of the screen. Use the scroll arrows to access the rest of the pages.

Symbol  indicates that the recording has not been displayed.

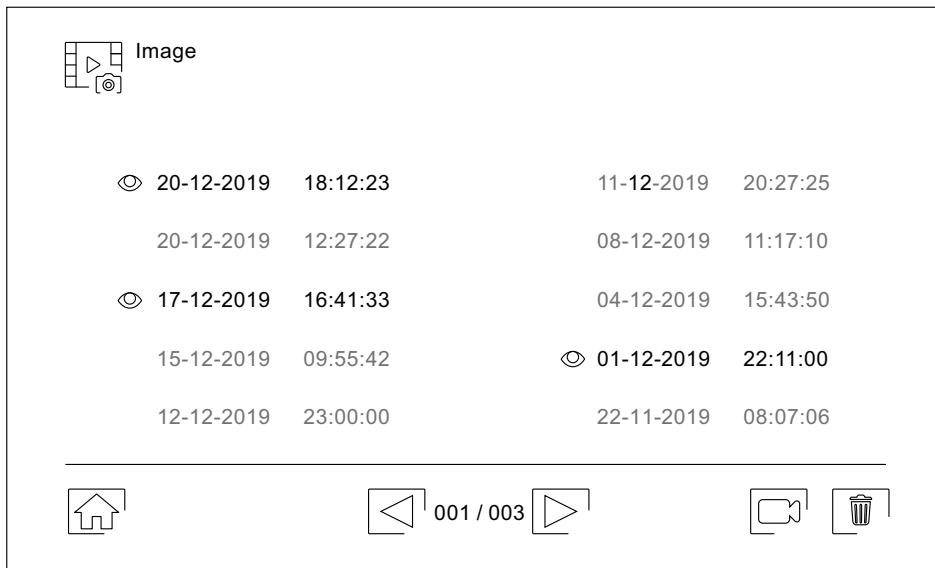
Use icon  to return to the main menu.



To delete one or more recordings from the list, use icon . Press on the recordings you wish to delete or use icon  to select all of them. Confirm your selection using icon : a warning screen will request your final confirmation.

Use icon  to return to the image recordings list.

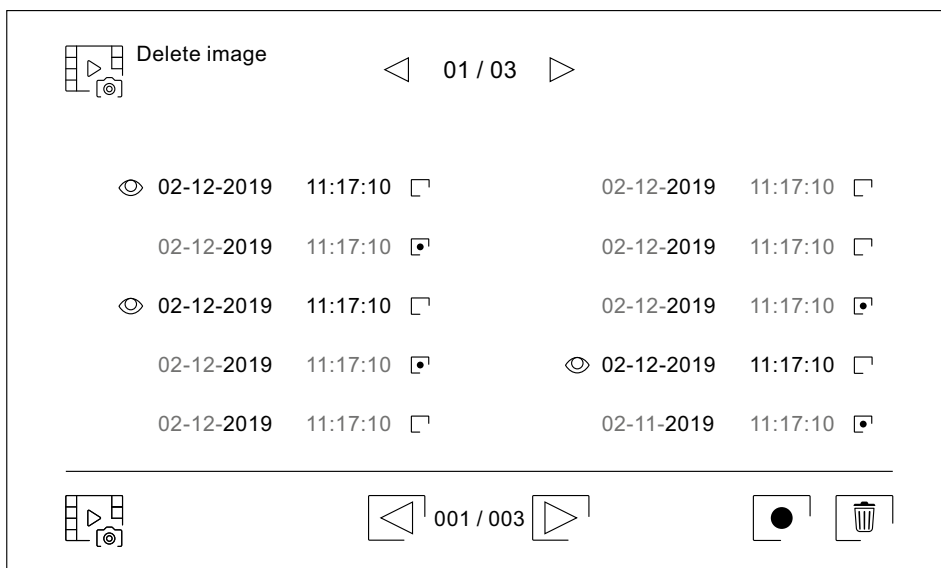

Important: New settings menu with ART 7W G2+ monitor with V.04 and later.

Continued overleaf



Continued from previous page.

ART 7W/G2+ MONITOR

Recordings menu

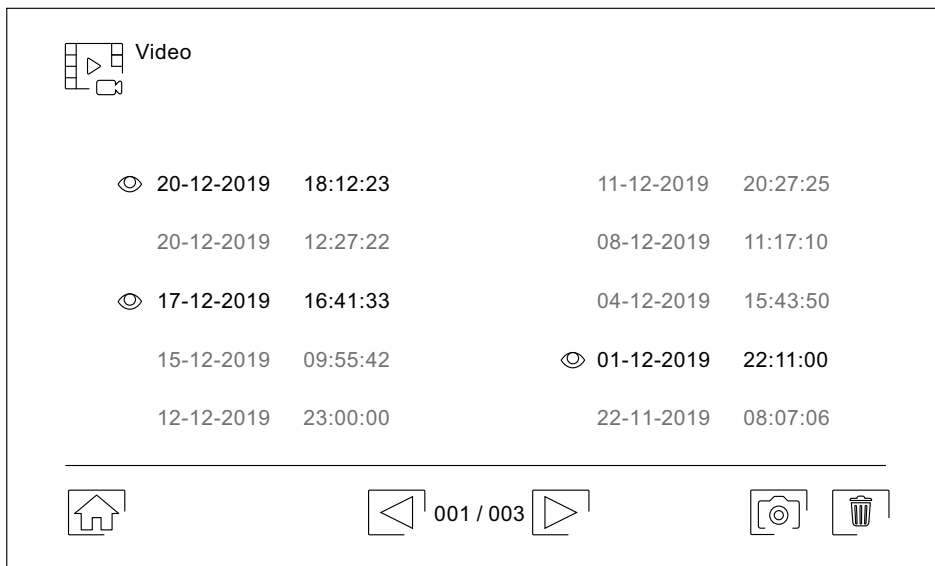
Press icon  to access the video recordings.



To delete one or more recordings from the list, use icon . Press on the recordings you wish to delete or use icon  to select all of them. Confirm your selection using icon : a warning screen will request your final confirmation.

Use icon  to return to the video recordings list.

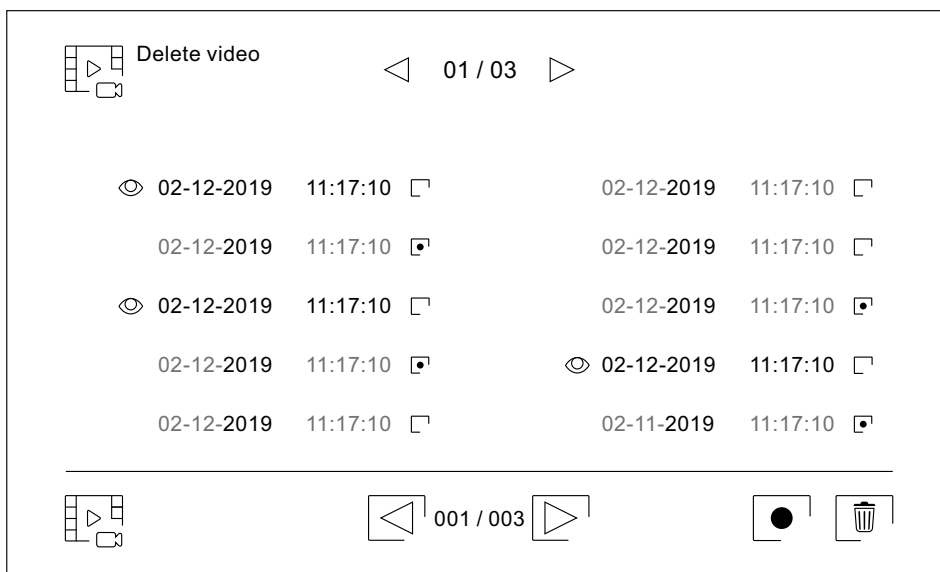





Important: New settings menu with ART 7W G2+ monitor with V.04 and later.

Continued overleaf

Continued from previous page.





ART 7W/G2+ MONITOR

Recordings menu

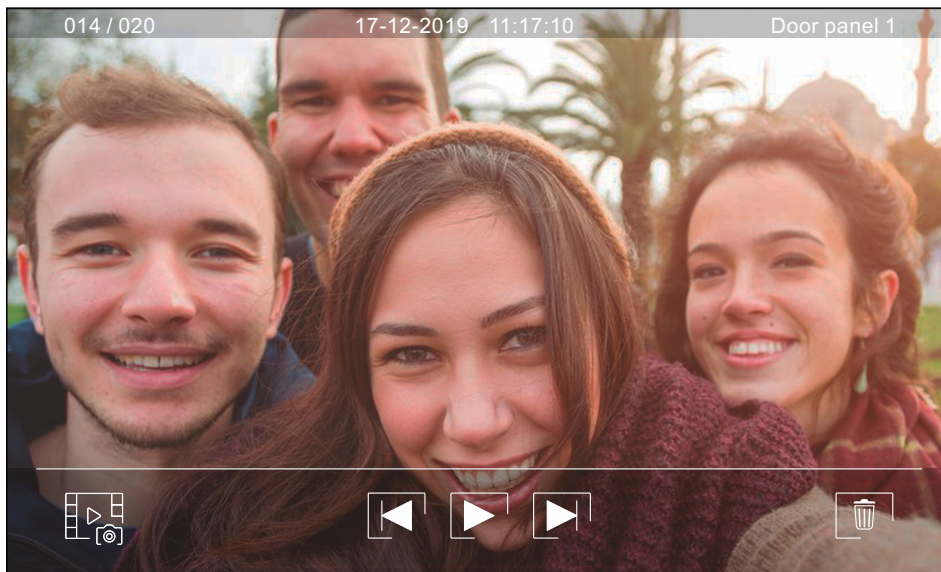
To view an image recording, select it in the list. The recording will be displayed full screen. Use the scroll arrows to display the next  or previous  recording. From this screen, you can also delete the recordings individually, which always requires your confirmation. Use icon  to play the images in sequence; press icon  to stop image playback.

Use icon  to return to the image recordings list.



To view a video recording, select it in the list. The recording will be displayed full screen. Use the scroll arrows to display the next  or previous  recording. From this screen, you can also delete the recordings individually, which always requires your confirmation. Use icon  to start playback of the video selected; press icon  to stop video playback.

Use icon  to return to the recordings list.

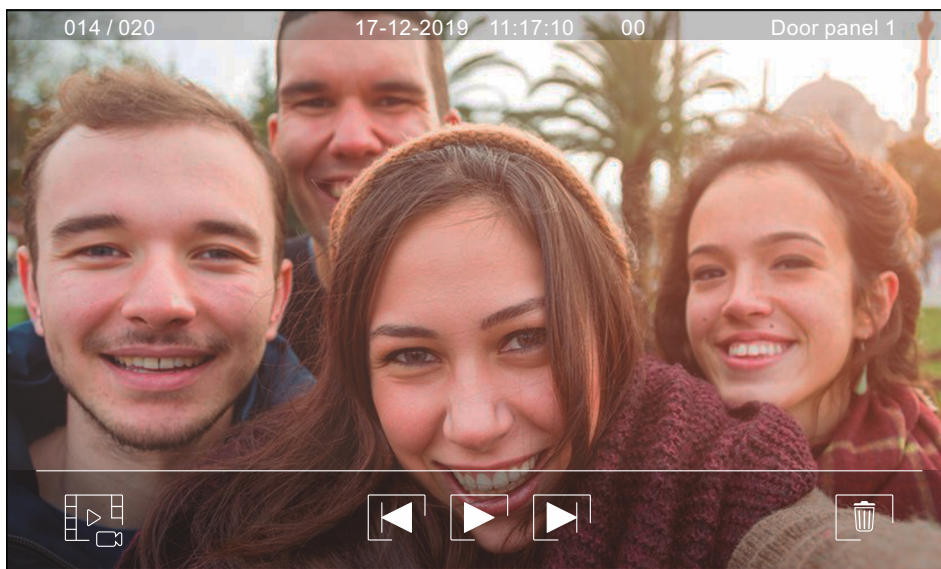

Important: New settings menu with ART 7W G2+ monitor with V.04 and later.

G2Call APP



Initial registering of a monitor to a Wi-Fi network

To register the monitor with the Wi-Fi network of your apartment, you will need to download and install the G2Call app on your phone. The app is available for Android® and iOS™ operating systems and you can download it free from Google Play and the Apple Store respectively.



Start the app once you have installed it on your mobile phone. Read the app's terms and conditions of use carefully: you can only access the app after accepting them. The app will request permissions to access certain functions of the phone, such as use of the speaker, microphone, etc. You must give your permission in order for the app to operate correctly.

During the registration process, some phones experience problems while they are connected to the mobile phone network. We recommend that you put your phone in flight mode with Wi-Fi activated during the registration process.

Turn on the Wi-Fi functionality of the master monitor using icon  in the main menu. Go to the Wi-Fi screen of the settings menu and check that pairing signal  appears in the top right of the screen.

To start registration, press the 'Add monitor' option. If there was already a monitor registered on your phone, press icon  to add a new monitor. Then press the 'New monitor' option, since this is the first time the monitor has been registered to the network of your apartment; if the monitor was previously registered to another network, reset the Wi-Fi settings as indicated on p. 15. Leave the app screen in the background and activate the Wi-Fi of your phone; connect to the network that starts with 'UID', return to the app screen and press 'Next'.

Select the Wi-Fi network that you are going to connect your monitor to. If you have more than one, select the nearest network to your monitor location. **Note:** Due to iOS operating system restrictions, it is not possible to display the list of available networks (see next page).

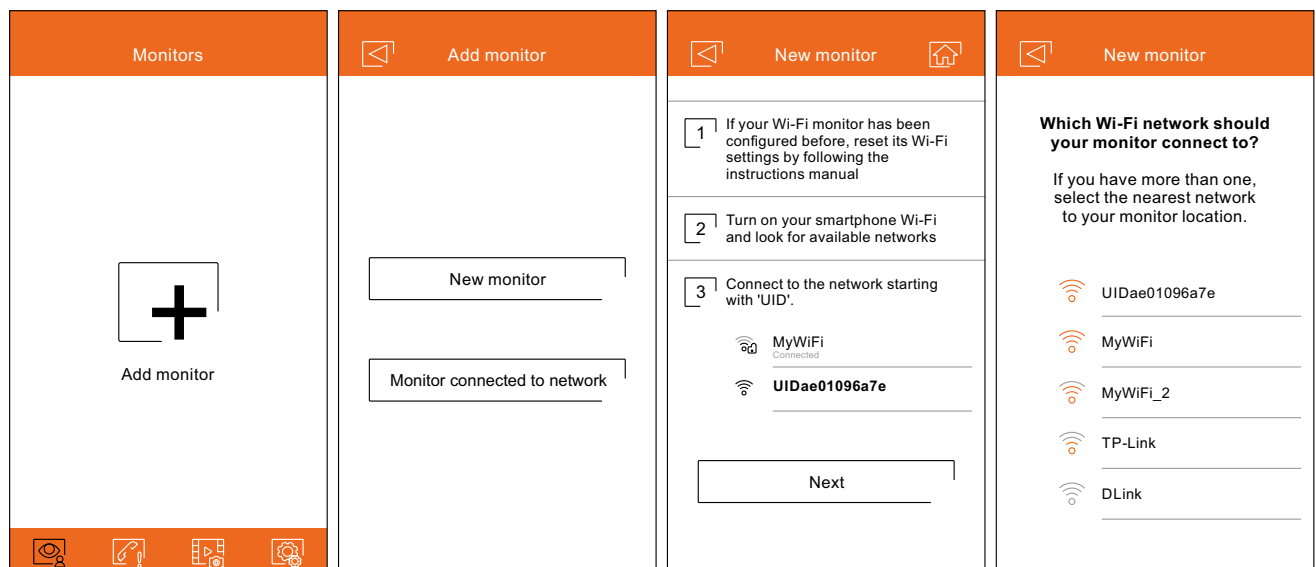

Android exclusive screen

G2Call APP

Initial registering of a monitor to a Wi-Fi network

Enter the network access password. If you are registering on a device with an iOS operating system, manually enter the SSID identifier of the network. By pressing 'Next', the pairing process will start and can take up to two and a half minutes.

If the pairing process successfully completes, the basic setup screen is displayed on the monitor. Assign it a name to differentiate it from other possible monitors that you have registered on the same phone. The factory setting of the connection password is '1234'. This password can only be changed once the monitor is registered. If the monitor is connected to a second door panel or surveillance cameras, indicate so.

If the pairing process fails, however, go to the Wi-Fi screen of the monitor settings menu and verify that it is connected to your Wi-Fi network: your network name should appear in the SSID field and the top right part of the screen should show the intensity bars of the connection signal. If so, register the monitor using the 'Monitor connected to network' option.

Once the process is finished, the registered monitor will appear as available.

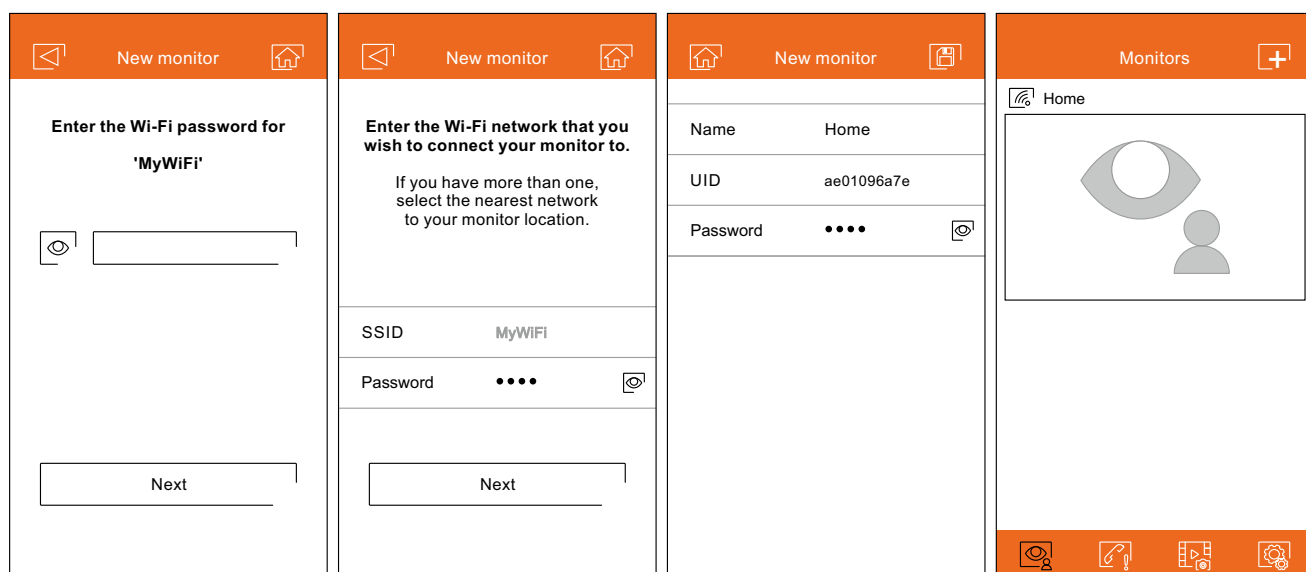

Android exclusive screen iOS exclusive screen

G2Call APP

Registering of a monitor connected to the network

Make sure your phone has connectivity, either Wi-Fi or through your telephone service provider. Pulse sobre la opción "Añadir monitor" o sobre el icono  para añadir un nuevo monitor. Seguidamente pulse sobre la opción "Monitor conectado a la red". Puede optar entre buscar monitores conectados en su red, debiendo estar el teléfono conectado a la misma, o introducir sus datos manualmente.

If you choose the 'Search' option, the app will show you the identifiers (UID) of the connected monitors. Select the monitor you wish to register in your app, showing the basic configuration screen of the monitor.

If you choose the 'Add manually' option, you can scan the QR code located on the back of the monitor with your phone, or manually enter the UID identifier (found on the Wi-Fi screen of the settings menu) on the monitor's basic setup screen.

Once the process is finished, the registered monitor will appear as available.

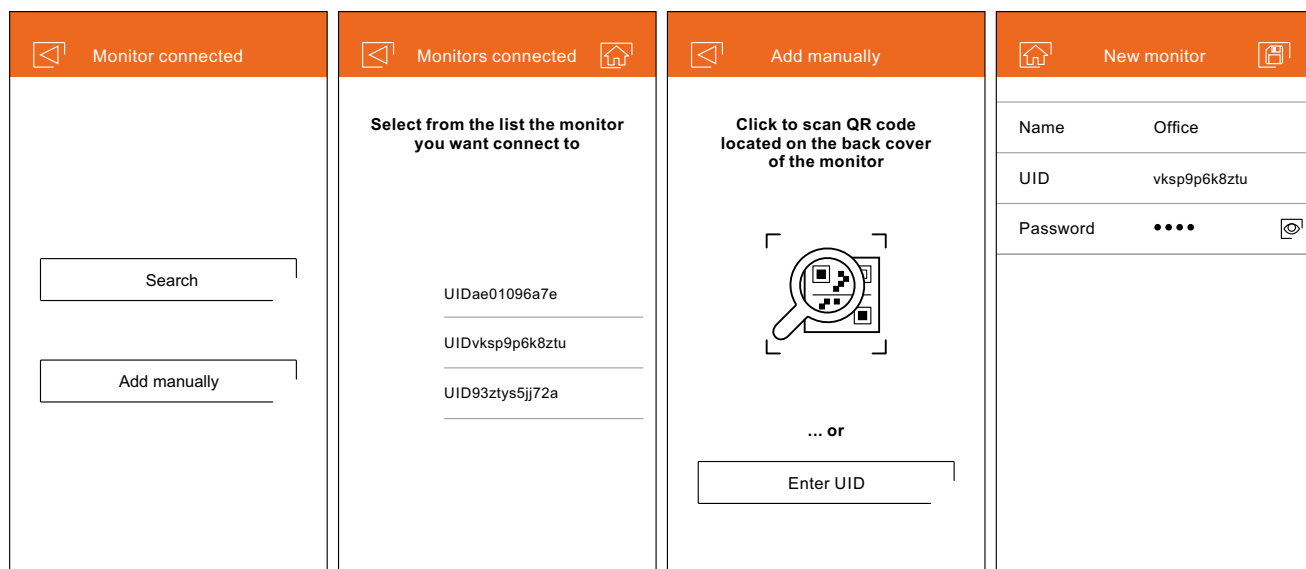



G2Call APP

Advanced settings of a registered monitor



To access the advanced settings of a monitor registered in the app, press the preview screen of that monitor and then icon  in the top right part of the screen. Even if the monitor is not connected at that time, you can adjust the settings.

ID.

To make changes to the monitor settings, the receipt of notifications must be turned off. In addition to the monitor settings, you can activate the password request function to unlock the door. This password is the same as that described on p. 25 and can be changed in advanced settings. This password will be requested to deactivate the function again.

Use icon  to change the settings. Once completed, save the settings using icon . To exit without saving changes, use icon .

Password.

Change the connection password to the monitor. It is the same password used to unlock the door if the function has been activated. Once the password has been changed, save the changes using icon . To exit without saving changes, use icon .















Note: This password is saved on the monitor. If another phone had access to this monitor, you need to also make changes to the basic settings of that monitor.

Push to talk.

The app has hands-free communication with the door panel. If you prefer, you can activate the 'Push to talk' function by marking the box.

Preview.

Set the quality of the default video signal (number of images per second) according to the type of data connection. It also defines whether the audio from the door panel to the phone is automatically activated upon receipt of the call, or whether it is necessary to press the pickup icon.

 Monitor settings	 ID 	 Password 	 Preview
ID	Name Home	Current 1 to 15 numbers	Audio 
Password	UID UID	New 1 to 15 numbers	Video quality High 
Push to talk 	Password ●●●● 	Confirm 1 to 15 numbers	Med 
Preview	PIN to unlock 		Low 
Wi-Fi			
Notification 			
FW Versión			
Time & Date synchronisation			
Delete			

G2Call APP

Advanced settings of a registered monitor

Wi-Fi.

Change the Wi-Fi network that the monitor is connected to with another one available in your environment.

Note: Due to iOS operating system restrictions, it is not possible to display the list of available networks, with it being necessary to manually enter the SSID identifier of the network.

Network changes can only be carried out when the phone is in the same location as the monitor.

Notification.

In order to receive call transfers from this monitor, it is necessary to activate the notification function. Deactivate this function if you only wish to connect to the device without having been called.

FW version.

This shows the FW version of this monitor and the latest version in the remote communications server, which can be updated. The app notifies of the existence of a new FW version by means of an alert above the advanced configuration icon of the monitor.

Time & Date synchronisation.

Update the time and date of the monitor with the phone data.

Delete.



Delete the app monitor. Receipt of notifications must be deactivated for the deletion.











G2Call APP

Main screen

When you run the app, and after the welcome screen, the selection screen of the connected monitors is displayed. Those with connectivity will show icon . To view the image from one of the devices, press your registered monitor to access the communication screen (see next page).

If you press icon , you will access the event screen. This screen shows the list of events: answered calls, missed calls and door openings. Each event shows the door panel number in brackets and the time it occurred. Swipe the screen downwards to refresh the list. By pressing icon , you can delete all events; if you press one of the events for 2 seconds, you can delete the events you select, or all simultaneously using icon .

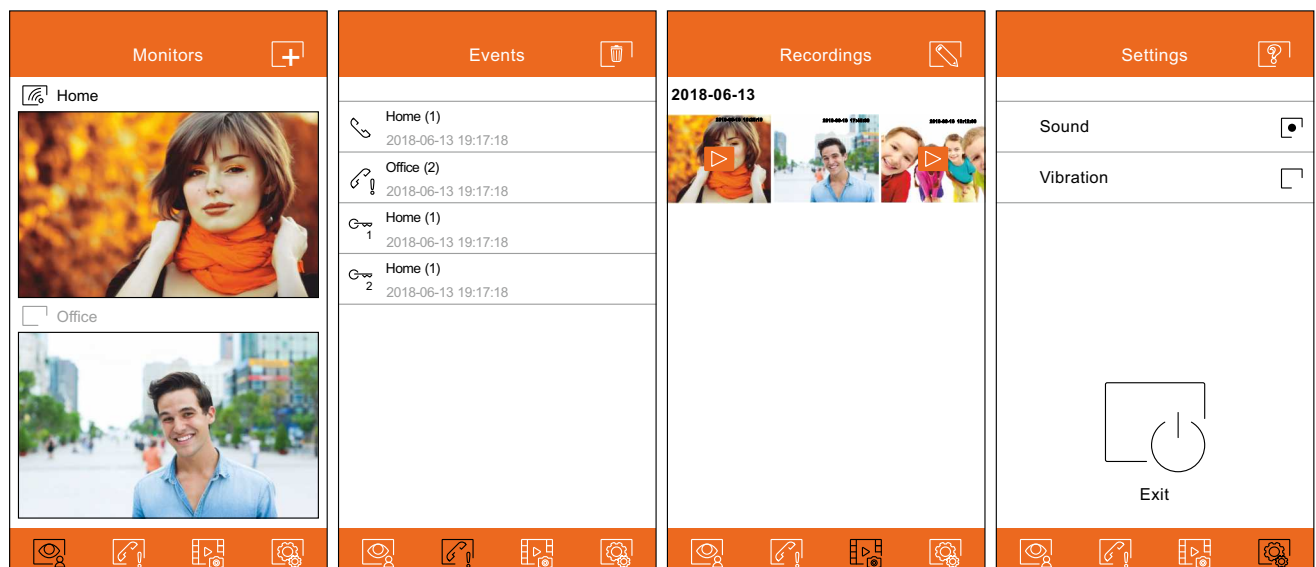

Icon  will take you to the screen that shows the images or videos recorded from the app. Press on any recording to view it in full screen, from where you can also share or delete it individually. By clicking on icon , you can delete and share several or all recordings simultaneously. To do so, use icons ,  and .

To access the app settings, press icon . From here, you can select if you want the phone to ring and/or vibrate when receiving a call. By clicking on icon , you can view the version of this app and Golmar's privacy policy. In the case of Android devices, exit the app using icon , or force its closure: it will continue receiving calls and the app will not consume battery.



G2Call APP

Communication screen

If you activated call transfer on the monitor and the notifications are activated on the app, you will receive calls made on the street panel. A pop-up screen will show you the origin of the call. You can accept the call using icon , or reject it by pressing . Once the call is accepted, you can establish audio communication by pressing icon .

Whether you access the communication screen through call reception or from the main screen, the options detailed below will be the same.

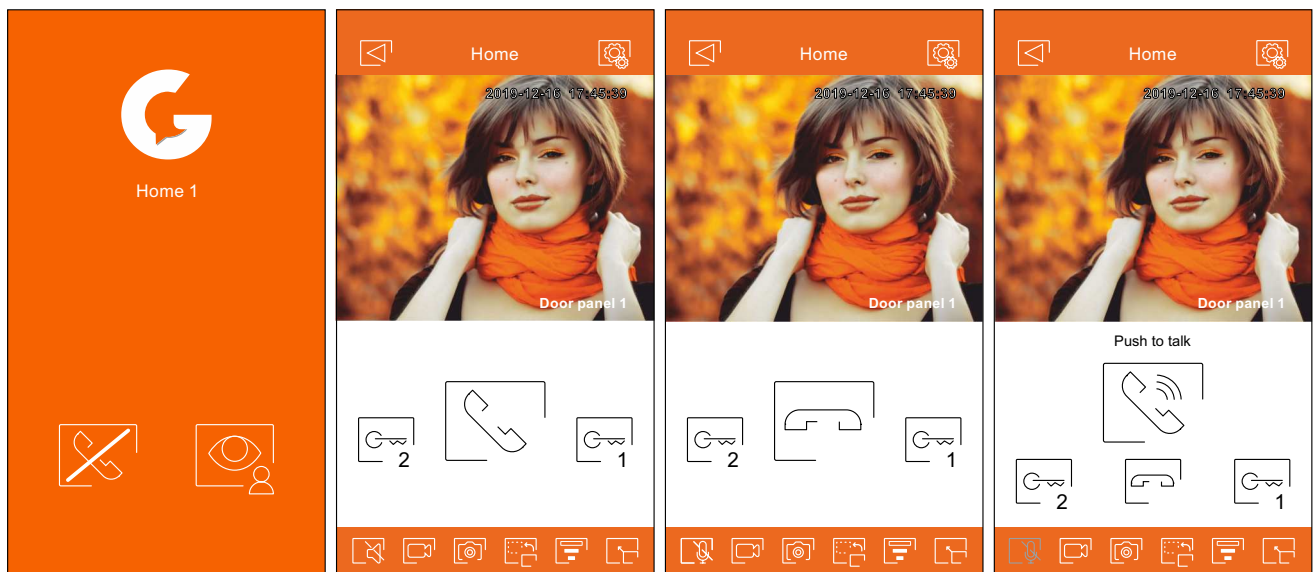

Activate or deactivate audio from the door panel during the viewing process. The initial state depends on the configuration of the preview of the monitor (p. 27).



Activate or deactivate the phone's microphone during the communication process. In communication mode, 'Push to talk' is deactivated.



Take a photograph.



Press to start recording a video. To end recording, press the icon again.



Change the source of the image. This icon appears enabled (white) if the system has more than one door panel or has an external camera connected and monitor display has been activated (see pp. 39-41). It is possible to make the change during display and communication processes.

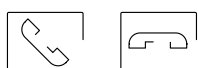

Start or end audio communication with the door panel displayed. Communication has a maximum duration of 90 seconds.



In 'Push to talk' communication mode, keep the button pressed while talking and release it to listen.

G2Call APP

Communication screen



Activate the lock release or device connected to the CV output of the door panel. You will need to enter a password for activation if one was defined on p. 27.



Activate the lock release or device connected to the relay output of the door panel. You will need to enter a password for activation if one was defined on p. 27.



Change the quality of the video signal according to the type of data connection.



Switch between full screen mode (horizontal orientation of the phone) and normal screen mode (vertical orientation).

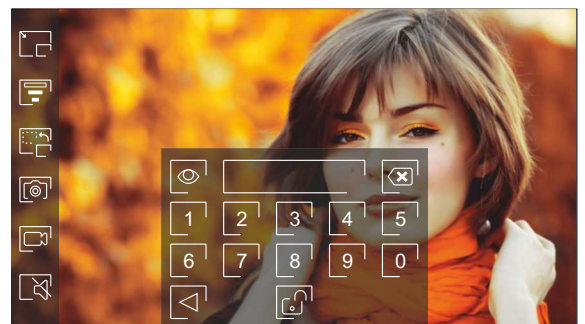
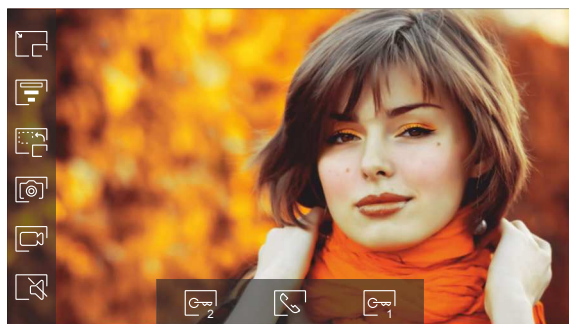

WIRING DIAGRAMS

Cross sections and distances

- The maximum number of monitors per apartment is 4.
- The maximum number of monitors in daisy chain connected is 12.

Type of cable	A	B	C
2 x 0.75mm ² (AWG18)	30 m	30 m	15 m
CAT5 (*)	60 m	60 m	30 m
RAP-GTWIN/HF	60 m	60 m	30 m

- A. Distance between power supply and furthest door panel.
- B. Distance between power supply and furthest monitor (or distributor).
- C. Distance between a distributor and the furthest monitor connected to one of its outputs.

(*) Use two twisted pairs for each bus line

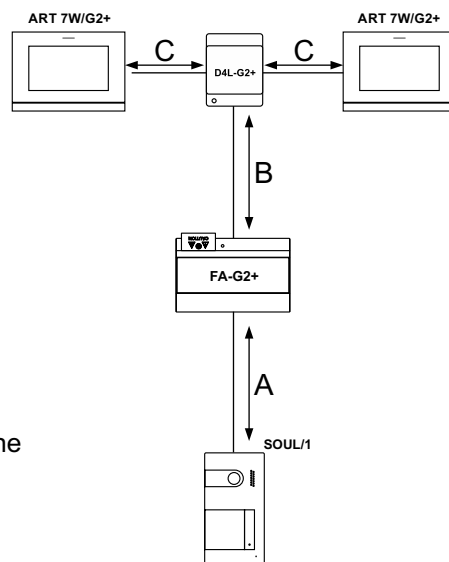

One apartment with one access panel and one monitor

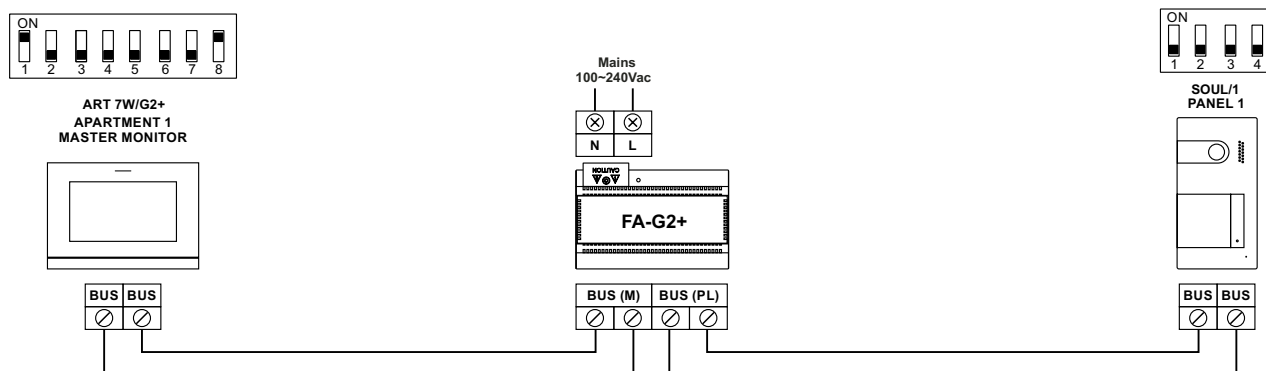

One apartment with two access panels and one monitor

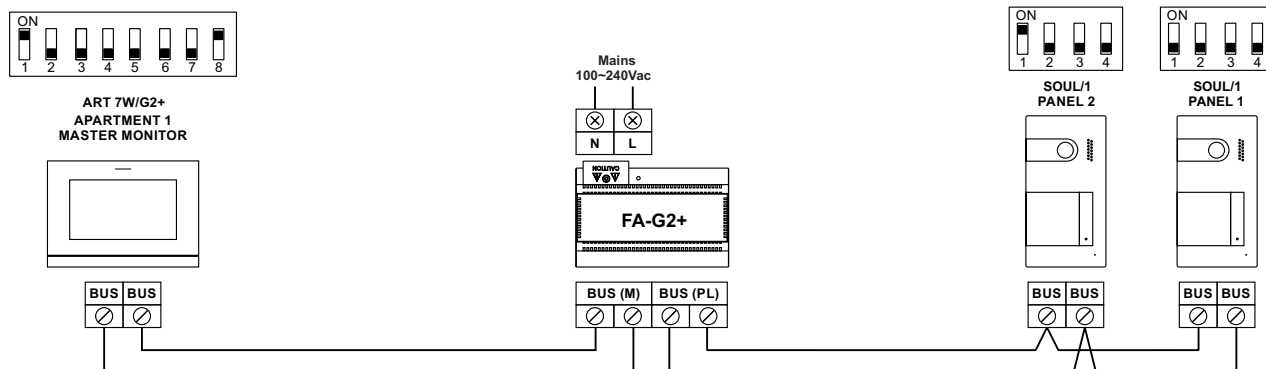

WIRING DIAGRAMS

One apartment with two access panels and up to four monitors in daisy chain connected

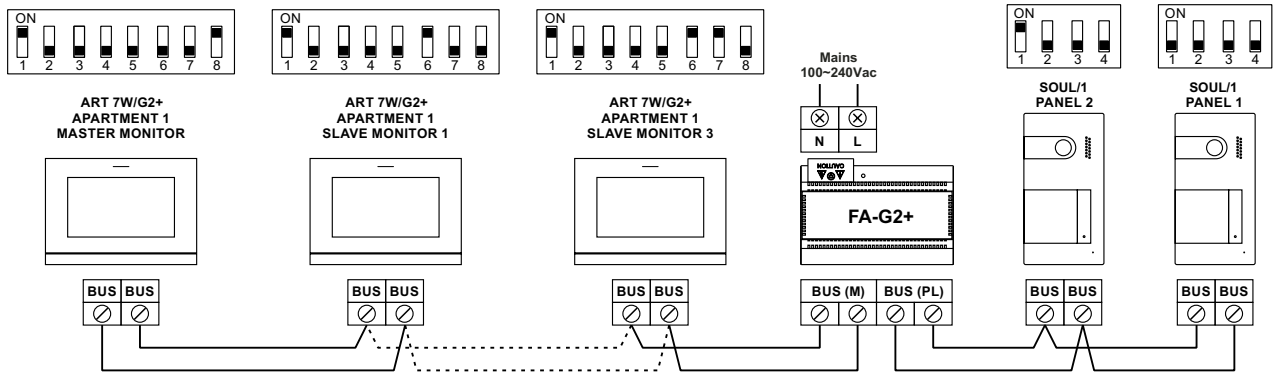

One apartment with two access panels and up to four monitors in distribution

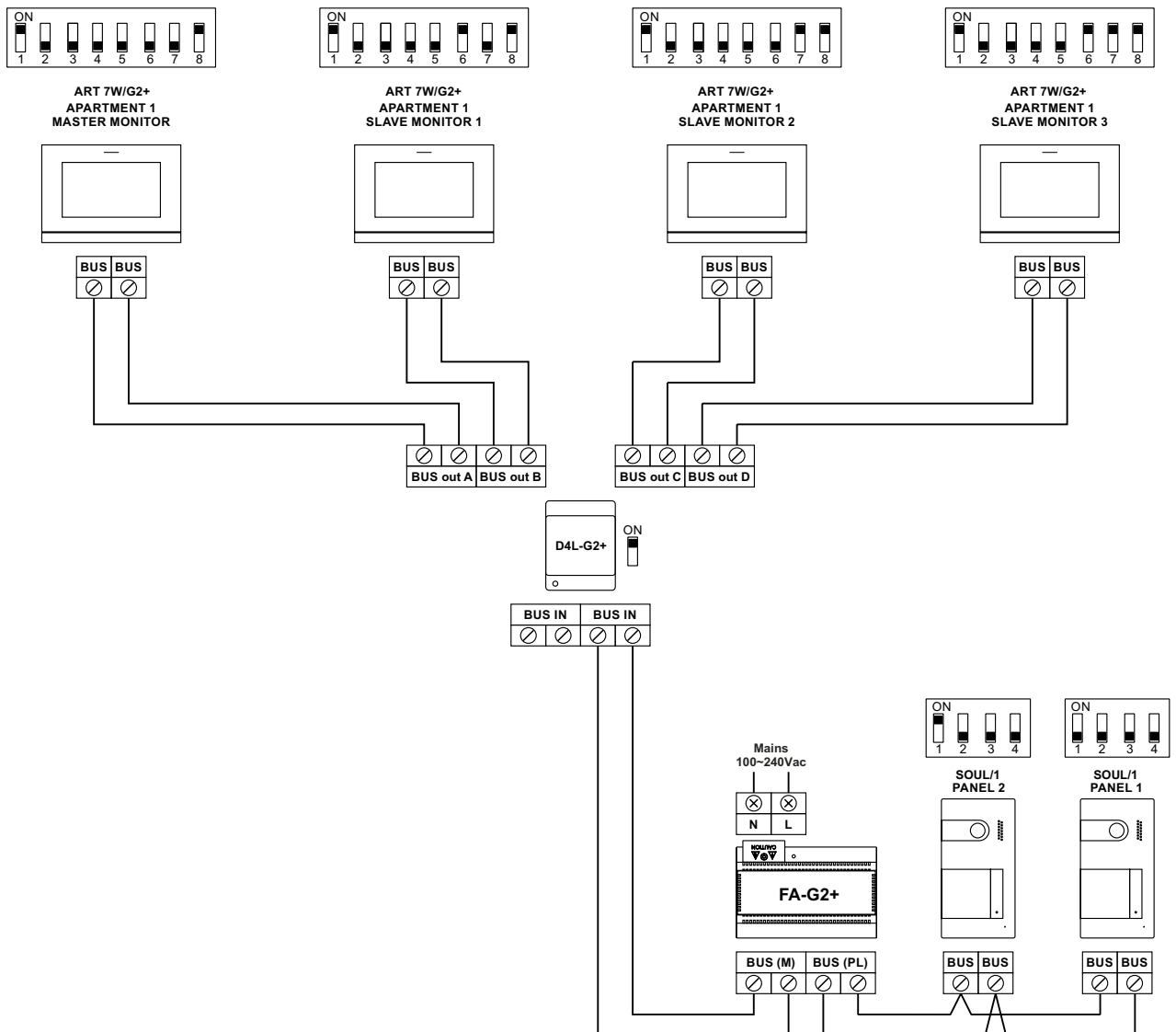

WIRING DIAGRAMS

Two apartments with two access panels and up to four monitors in daisy chain connected

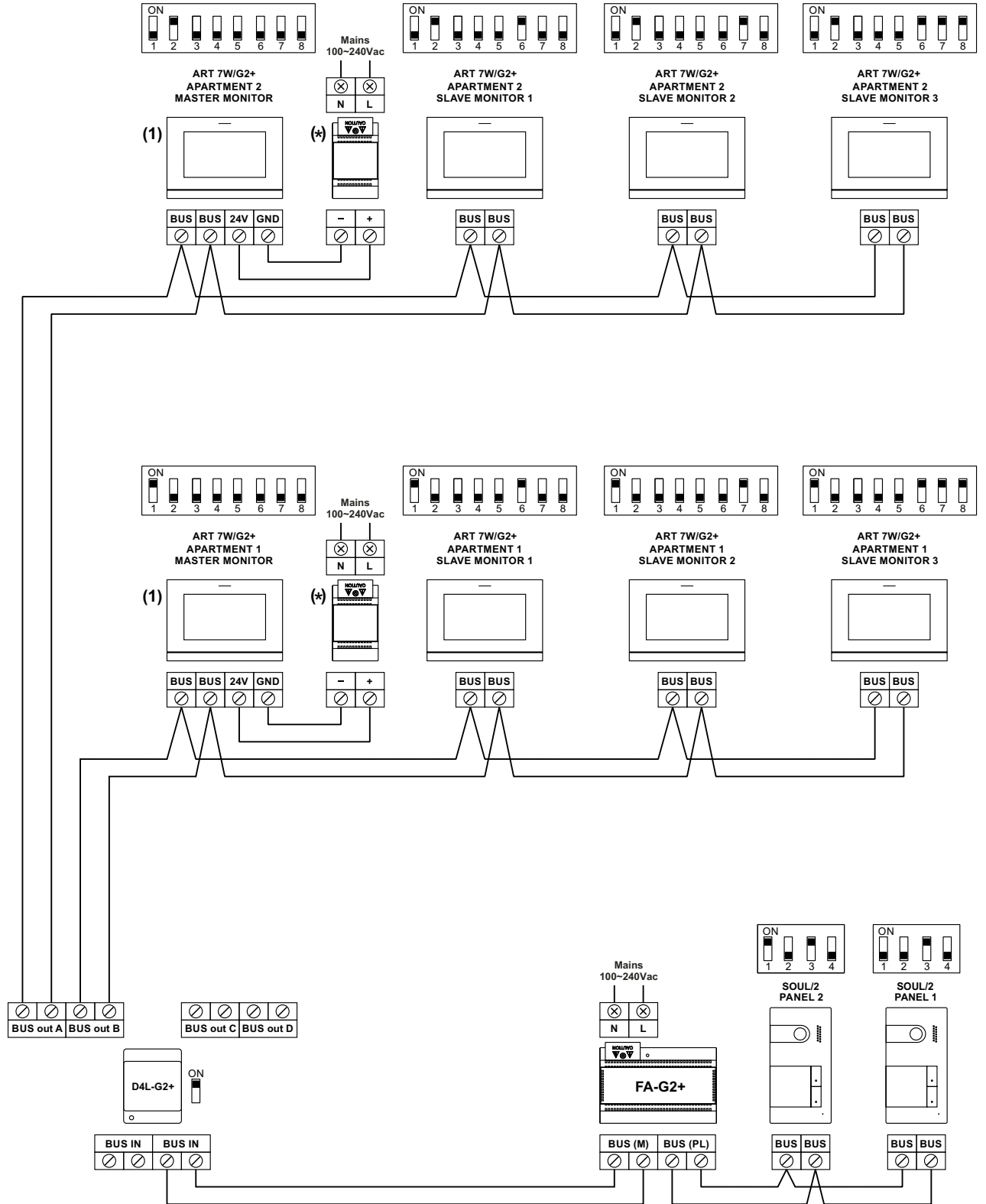

(1) Important: Only the master monitor can activate Wi-Fi transmission.

(*) FA-ART 7W power supply.

WIRING DIAGRAMS

Four apartments with two access panels and up to four monitors in daisy chain connected

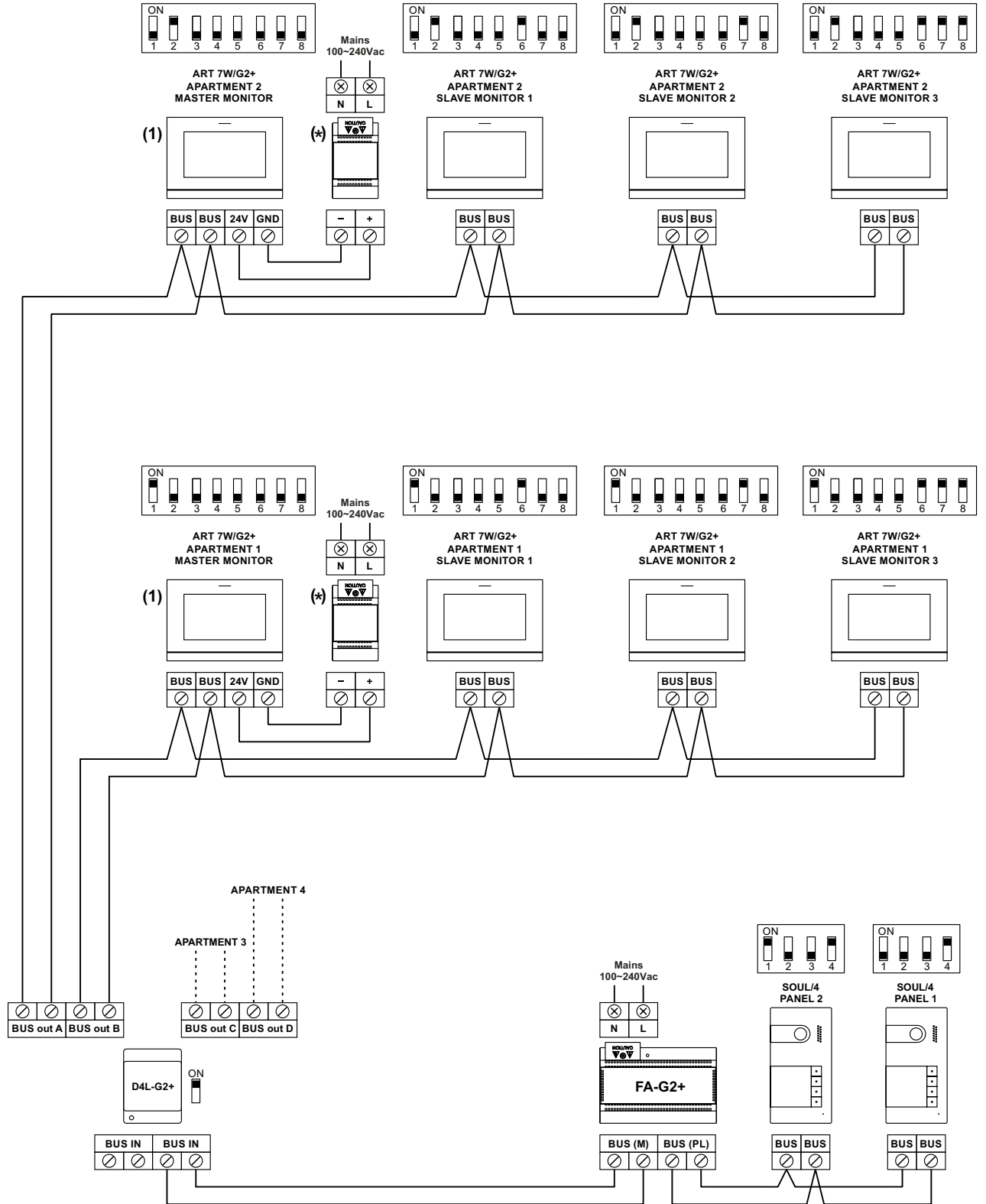

(1) Important: Only the master monitor can activate Wi-Fi transmission.

(*) FA-ART 7W power supply.

WIRING DIAGRAMS

Four apartments with four access panels and up to four monitors in daisy chain connected

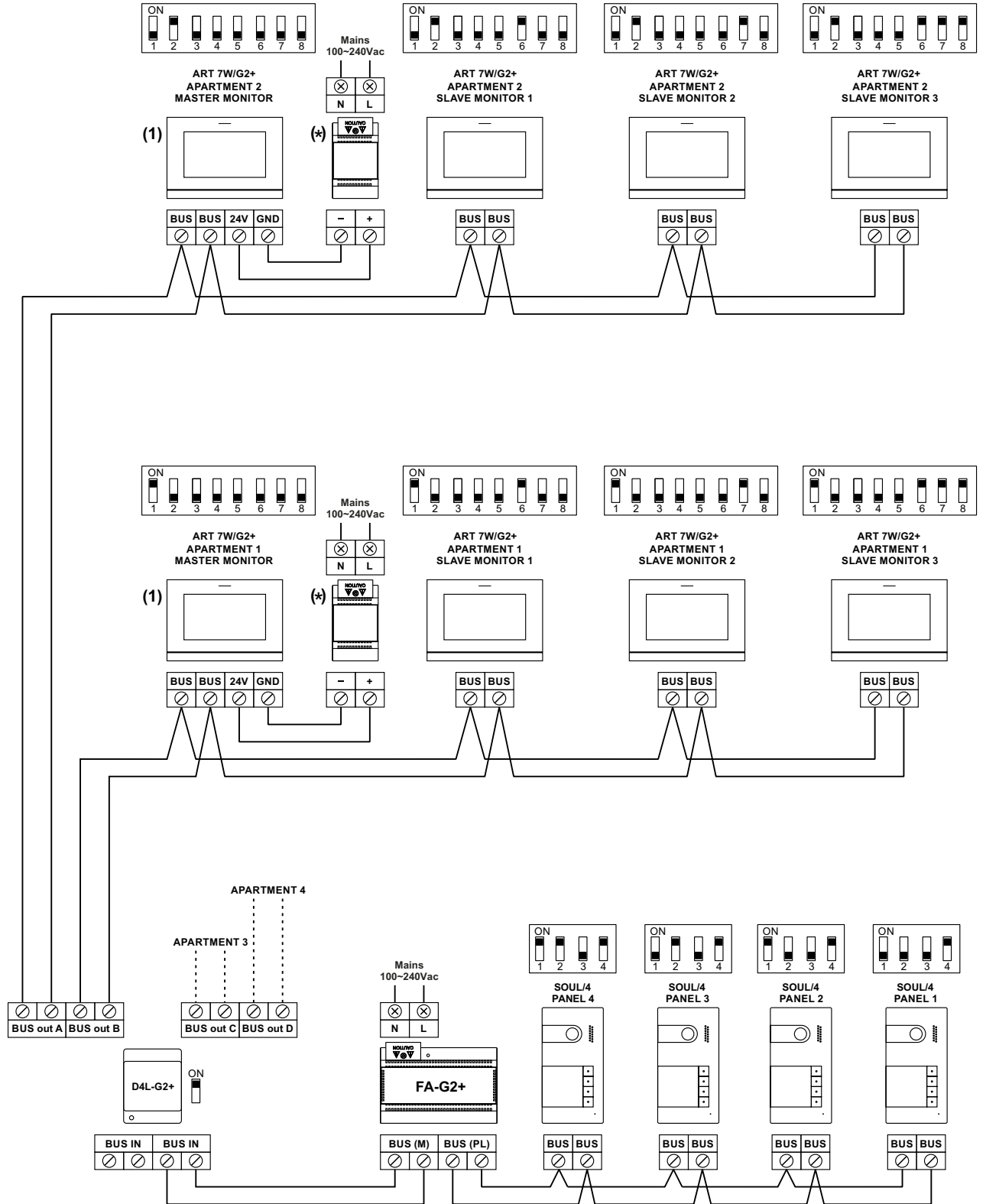

(1) Important: Only the master monitor can activate Wi-Fi transmission.

(*) FA-ART 7W power supply.

WIRING DIAGRAMS

Connection of a lock release

The drawing shows the connection of a 12Vdc lock release, with a maximum consumption of 150mA.

The use of Golmar CV-14/DC, CV-24/DC, CV-14P/UNI or CV-24P/UNI models is recommended. Activation is carried out through icon . The activation time is 3 seconds with the possibility of setting it to between 0.5 and 10 seconds. (see pp. 39-41)

A varistor is supplied with each door station. If powering a DC lock this **must** be connected.

Failure to use the supplied varistor will VOID the warranty.

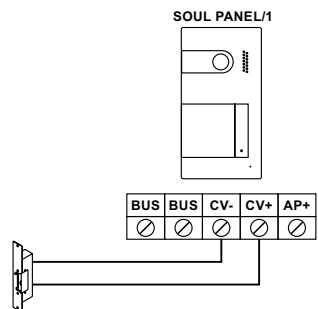

If the lock release to be used is alternating current, use a relay and transformer suitable for the consumption, as well as the varistor supplied. The example shows a Golmar SAR-12/24 relay and a TF-104 transformer (12Vac/1.5A).

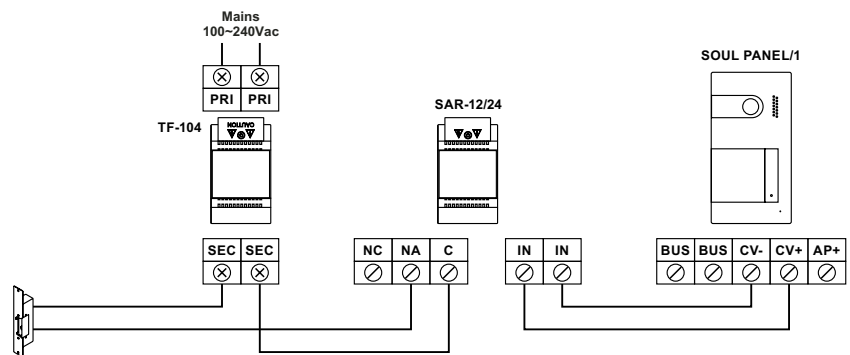

Connection of an auxiliary device at the relay output

The drawing, by way of example, shows the connection of a second AC lock release. The relay can switch 6A/24V loads. Activation is carried out through icon . The activation time is 3 seconds with the possibility of setting it to between 0.5 and 10 seconds (see pp. 39-41).

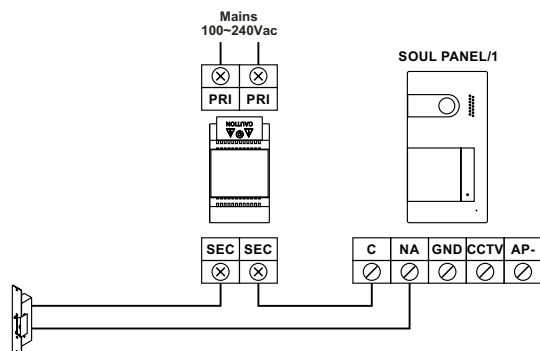

WIRING DIAGRAMS

Connection of an output button

The output button allows remote activation of the lock release connected between the CV- and CV+ terminals (by default) or the relay output (see pp. 39-41). The delay time in carrying out the activation is 2 seconds, with the possibility of setting it to between 0.5 and 10 seconds (see pp. 39-41).

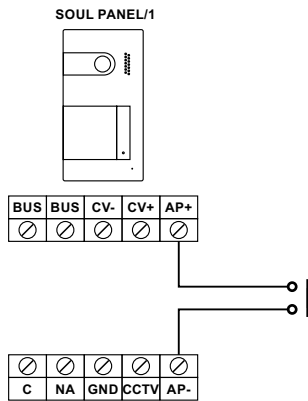

Connection of an external camera

It is possible to connect a Golmar AHD4-3601x analogue CCTV camera to each of the door panels, which can be viewed (see pp. 39-41) from the monitor. The camera needs to have a local PSU-121 power supply.

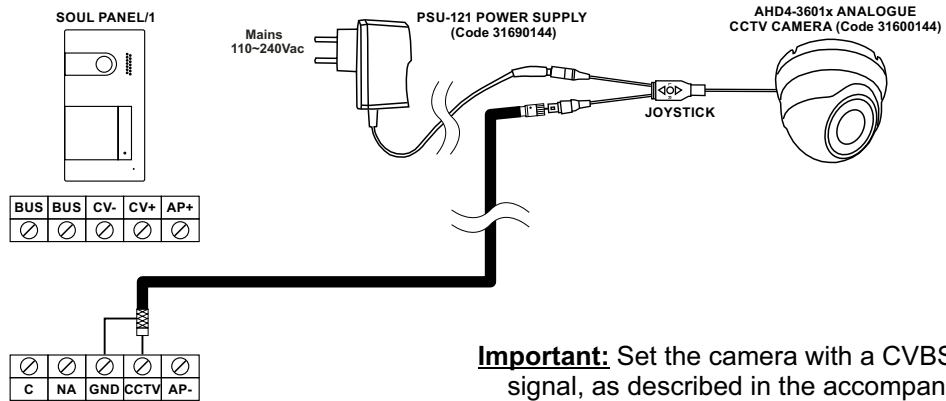

Important: Set the camera with a CVBS analogue signal, as described in the accompanying AHD4-3601x camera manual.

Connection for an apartment door button

Only connect the apartment door button to the master monitor of the apartment that will be receiving the call. The signal received is then transmitted to the slave monitors in the same apartment.

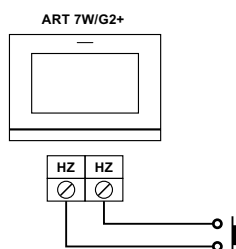



SPECIAL CODES

The enabling of some functions, as well as the modification of some factory parameters, can be carried out by entering special codes. To do so, the installer menu must be accessed from the monitor. Go to the 'About' screen in the settings menu (p. 15) and press five times on icon  in the top left of the screen to bring up a keyboard to enter the codes.

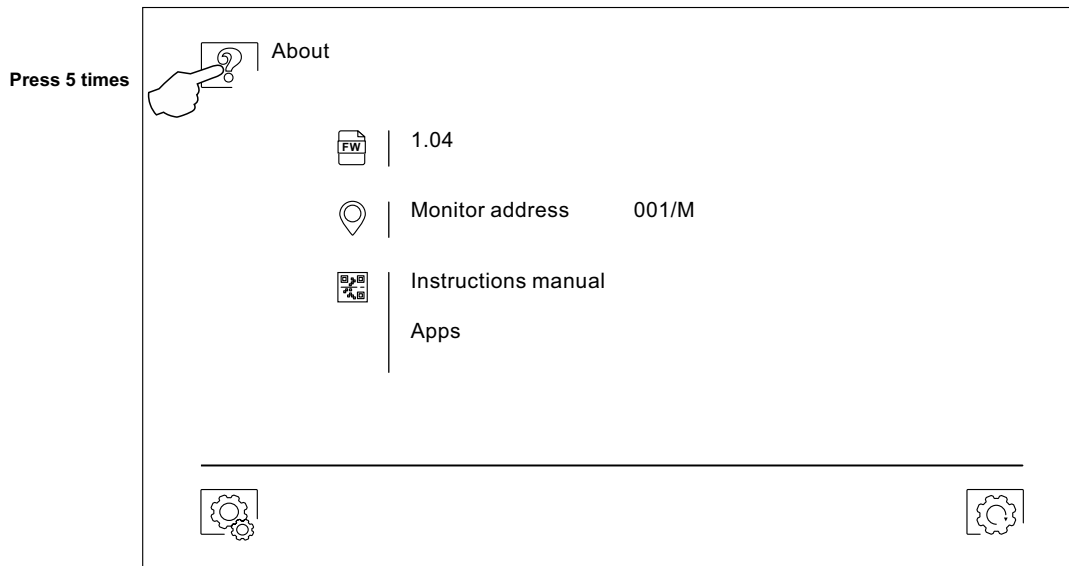
'About' screen



The 'special codes' screen will then be displayed. The codes must be entered one by one and validated using icon . If the code entered is valid, the 'OK' message will be displayed; if not, the 'ERROR' message will be displayed.

Use icon  to return to the 'About' screen.

'Special codes' screen

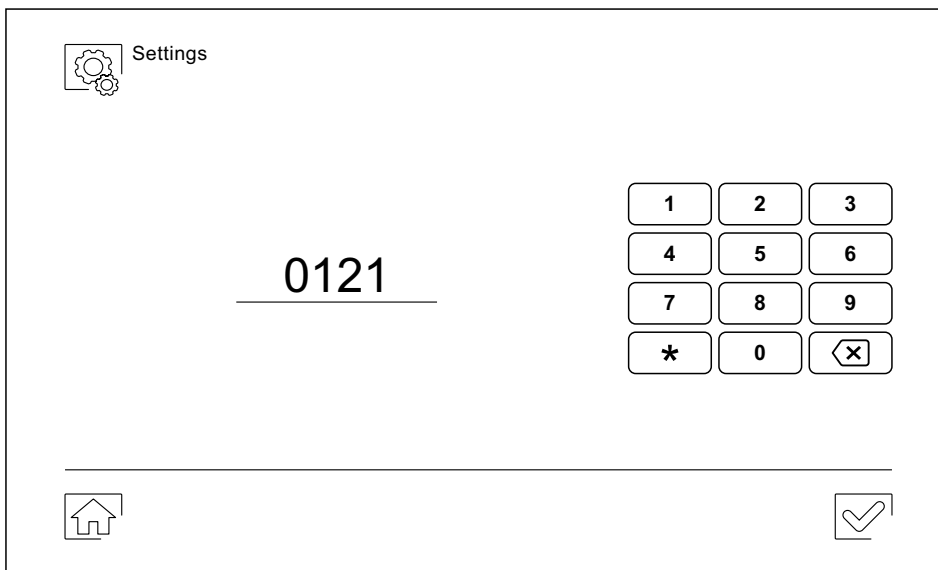

Important: New settings menu with ART 7W G2+ monitor with V.04 and later.

Continued overleaf

Continued from previous page.

SPECIAL CODES

Video sources available on a monitor (configure only on the master monitor).

	<u>Visible</u>	<u>Not visible</u>	<u>Factory setting</u>
Door panel 1	0111	0110	0111
Door panel 2	0121	0120	0120
(*) Door panel 3	0131	0130	0130
(*) Door panel 4	0151	0150	0150
Camera 1	0141	0140	0140
Camera 2	0181	0180	0180
(*) Camera 3	0171	0170	0170
(*) Camera 4	0191	0190	0190

(*) Important: SOUL/1, SOUL/2 and SOUL/4 door panels with version V04 and later.

Automatic door opening upon reception of a call on a monitor (configure only on the master monitor).

<u>Activated</u>	<u>Deactivated</u>	<u>Factory setting</u>
0441	0440	0440

Activate/deactivate the hidden start/stop communication and door opening button on a monitor (hidden buttons located above raised dots ● / ●● for the visually impaired).

<u>Activate</u>	<u>Deactivate</u>	<u>Factory setting</u>
0461	0460	0460(deactivated)

Activate/deactivate the ('power indicator' notification icon) on a monitor.

<u>Activate</u>	<u>Deactivate</u>	<u>Factory setting</u>
0471	0470	0471 (activated)

Do not show the image on the monitor when receiving a call from the door panel when the monitor is in 'Do not disturb' mode.

<u>Do not show</u>	<u>Show</u>	<u>Factory setting</u>
0481	0480	0480 (show image)

Activation times of the outputs (Door panel 1). (Configure only on the master monitor).

		<u>Factory setting</u>
Lock release	From 0200 (0.5s) to 0219 (10s)	0205 (3s)
Relay	From 0300 (0.5s) to 0319 (10s)	0305 (3s)

Configuration of the remote activation button (Door panel 1). (Configure only on the master monitor).

		<u>Factory setting</u>
Delay	From 0400 (0.5s) to 0419 (10s)	0403 (2s)
Output	0430 (lock release) or 0431 (relay)	0430 (lock release)

Activation times of the outputs (Door panel 2). (Configure only on the master monitor).

		<u>Factory setting</u>
Lock release	From 1200 (0.5s) to 1219 (10s)	1205 (3s)
Relay	From 1300 (0.5s) to 1319 (10s)	1305 (3s)

Configuration of the remote activation button (Door panel 2). (Configure only on the master monitor).

		<u>Factory setting</u>
Delay	From 1400 (0.5s) to 1419 (10s)	1403 (2s)
Output	1430 (lock release) or 1431 (relay)	1430 (lock release)

Important: New settings menu with ART 7W G2+ monitor with V.04 and later.

Continued overleaf

Continued from previous page.

SPECIAL CODES

(*) Activation times of the outputs (Door panel 3). (Configure only on the master monitor).

		<u>Factory setting</u>
Lock release	From 2200 (0.5s) to 2219 (10s)	2205 (3s)
Relay	From 2300 (0.5s) to 2319 (10s)	2305 (3s)

(*) Configuration of the remote activation button (Door panel 3). (Configure only on the master monitor).

		<u>Factory setting</u>
Delay	From 2400 (0.5s) to 2419 (10s)	2403 (2s)
Output	2430 (lock release) or 2431 (relay)	2430 (lock release)

(*) Activation times of the outputs (Door panel 4). (Configure only on the master monitor).

		<u>Factory setting</u>
Lock release	From 3200 (0.5s) to 3219 (10s)	3205 (3s)
Relay	From 3300 (0.5s) to 3319 (10s)	3305 (3s)

(*) Configuration of the remote activation button (Door panel 4). (Configure only on the master monitor).

		<u>Factory setting</u>
Delay	From 3400 (0.5s) to 3419 (10s)	3403 (2s)
Output	3430 (lock release) or 3431 (relay)	3430 (lock release)

LED lights for night viewing (Door panel 1) during a call or communication process. (Configure only on the master monitor).

<u>Automatic</u>	<u>Always ON</u>	<u>Always OFF</u>	<u>Factory setting</u>
0450	0451	0452	0450 (automatic).

LED lights for night viewing (Door panel 2) during a call or communication process. (Configure only on the master monitor).

<u>Automatic</u>	<u>Always ON</u>	<u>Always OFF</u>	<u>Factory setting</u>
1450	1451	1452	1450 (automatic).

(*) LED lights for night viewing (Door panel 3) during a call or communication process. (Configure only on the master monitor).

<u>Automatic</u>	<u>Always ON</u>	<u>Always OFF</u>	<u>Factory setting</u>
2450	2451	2452	2450 (automatic).

(*) LED lights for night viewing (Door panel 4) during a call or communication process. (Configure only on the master monitor).

<u>Automatic</u>	<u>Always ON</u>	<u>Always OFF</u>	<u>Factory setting</u>
3450	3451	3452	3450 (automatic).

Activate/deactivate audible confirmation (Door panel 1). (Configure only on the master monitor).

<u>Activated</u>	<u>Deactivated</u>	<u>Factory setting</u>
1701	1700	1701

Activate/deactivate audible confirmation (Door panel 2). (Configure only on the master monitor).

<u>Activated</u>	<u>Deactivated</u>	<u>Factory setting</u>
2701	2700	2701

(*) Activate/deactivate audible confirmation (Door panel 3). (Configure only on the master monitor).

<u>Activated</u>	<u>Deactivated</u>	<u>Factory setting</u>
3701	3700	3701

(*) Activate/deactivate audible confirmation (Door panel 4). (Configure only on the master monitor).

<u>Activated</u>	<u>Deactivated</u>	<u>Factory setting</u>
4701	4700	4701

Important: New settings menu with ART 7W G2+ monitor with V.04 and later.

CLEANING THE MONITOR

- Do not use solvents, detergents or cleaning products that contain acids, vinegar or abrasive components.
- Use a soft damp cloth (not wet) that sheds no fibres.
- Always wipe the monitor in the same direction, from top to bottom.
- After cleaning the monitor, remove any moisture with a soft dry cloth that sheds no fibres.

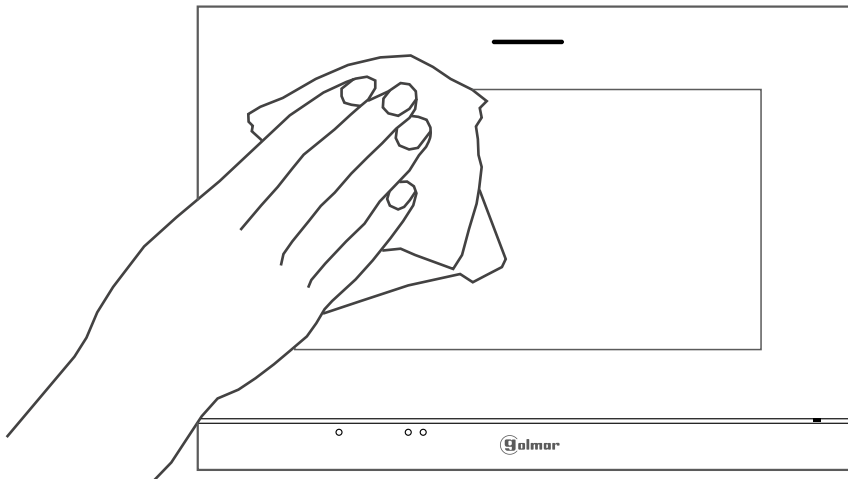
**CLEANING THE DOOR PANEL**

- Do not use solvents, detergents or cleaning products that contain acids, vinegar or abrasive components.
- Use a soft damp cloth (not wet) that sheds no fibres.
- Always wipe the door panel in the same direction, from top to bottom.
- After cleaning the door panel, remove any moisture with a soft dry cloth that sheds no fibres.

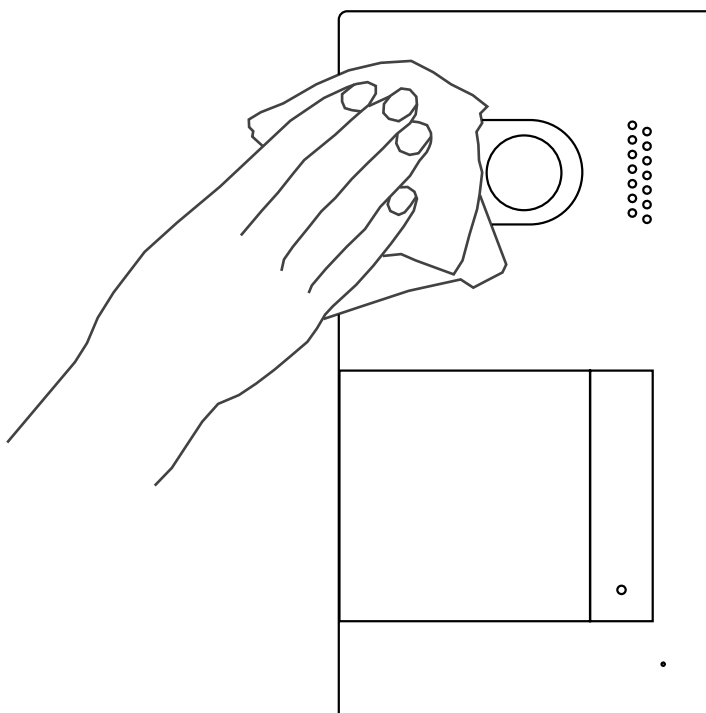

COMPLIANCE:

Este producto es conforme con las disposiciones de las Directivas Europeas aplicables respecto a Equipos de Radio **2014/53/CEE**, a la Seguridad Eléctrica **2014/35/CEE** y la Compatibilidad Electromagnética **2014/30/CEE**.

*This product meets the essentials requirements of applicable European Directives regarding Radio Equipment **2014/53/ECC**, Electrical Safety **2014/35/ECC** and Electromagnetic Compatibility **2014/30/ECC**.*



NOTA: El funcionamiento de este equipo está sujeto a las siguientes condiciones:

(1) Este dispositivo no puede provocar interferencias dañinas, y (2) debe aceptar cualquier interferencia recibida, incluyendo las que pueden provocar un funcionamiento no deseado.

NOTE: Operation is subject to the following conditions:

(1) This device may not cause harmful interference, and (2) this device must accept any received interference, including the ones that may cause undesired operation.



golmar@golmar.es

www.golmar.es

GOLMAR S.A.
C/ Silici, 13
08940- Cornellá de Llobregat
SPAIN



Golmar se reserva el derecho a cualquier modificación sin previo aviso.

Golmar se réserve le droit de toute modification sans préavis.

Golmar reserves the right to make any modifications without prior notice.